

LIBERA

Installation manual

Dimensions:
120x180 cm
150x180 cm
150x200 cm
200x200 cm
200x250 cm

Handedness:
Left

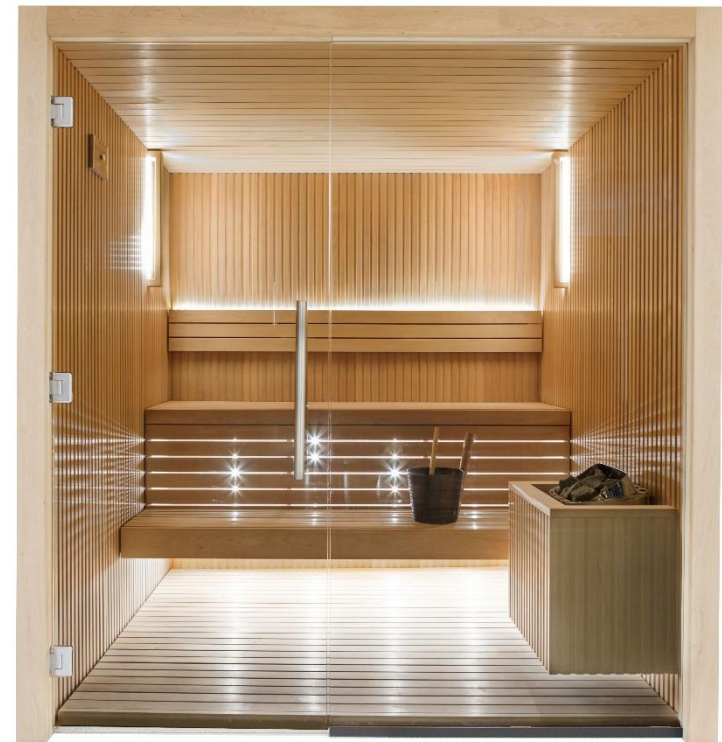

Leave space for better assembly

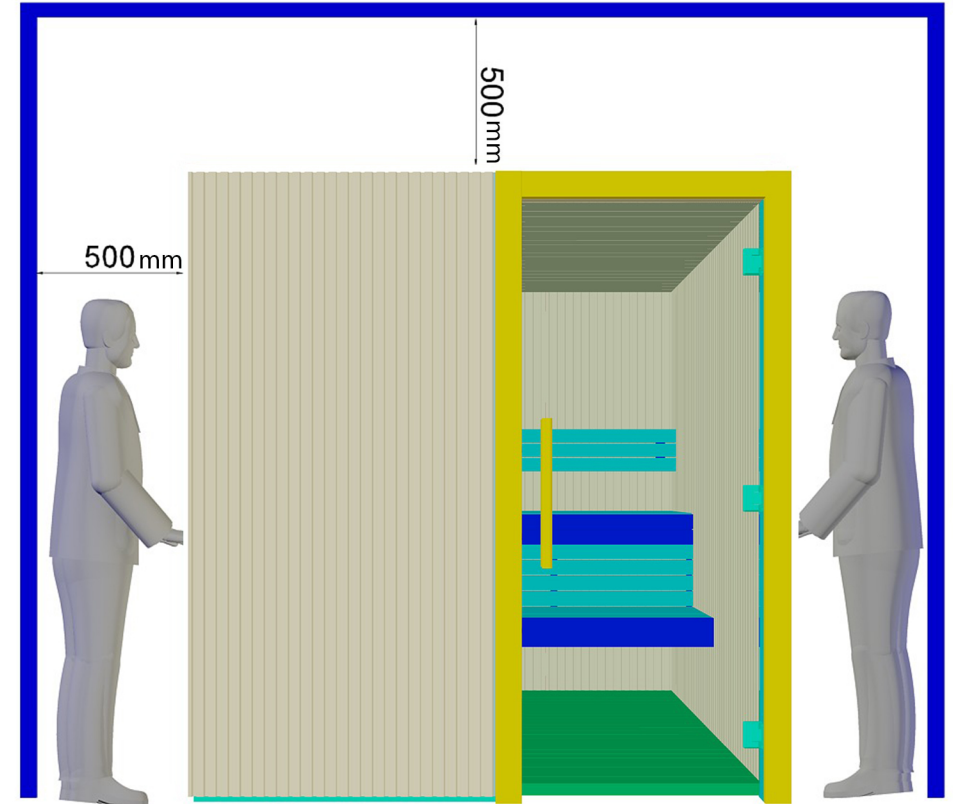
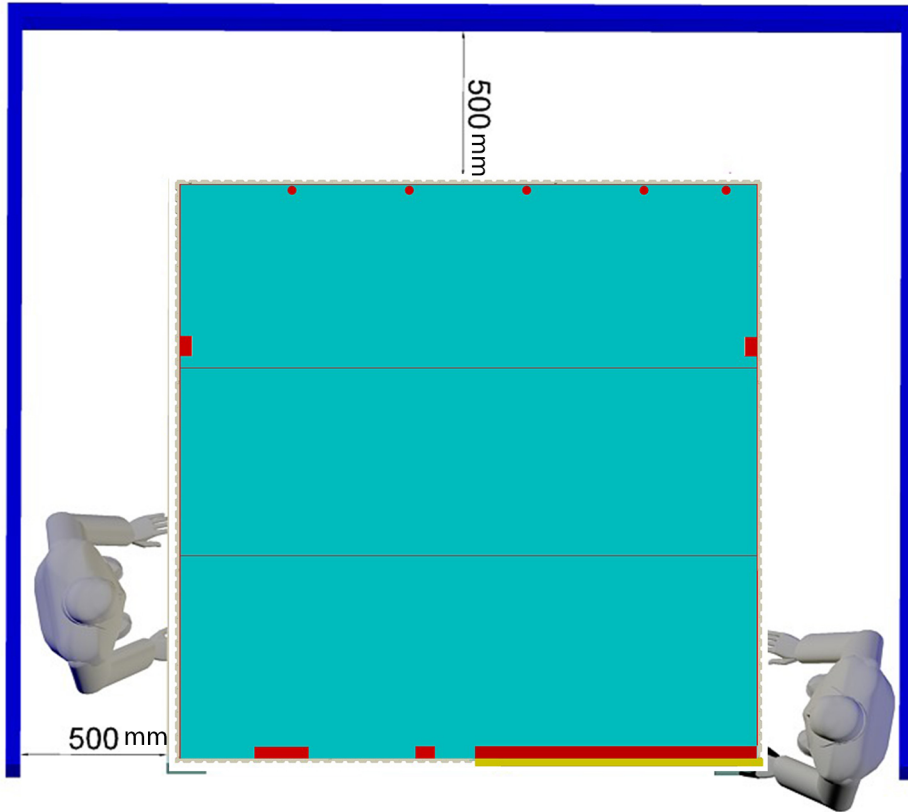

Tools

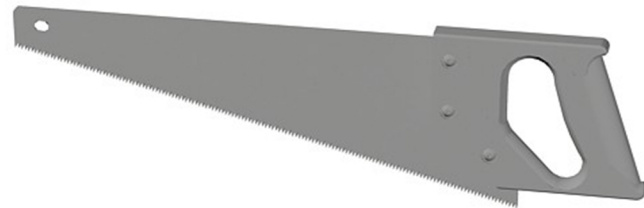
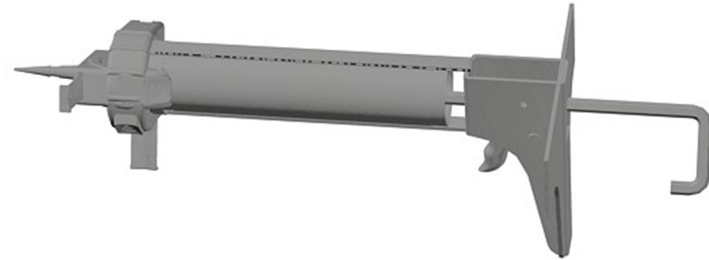

1. Base frame

	x (mm)	y (mm)
120x180 cm	2115	1770
150x180 cm	2293	1770
150x200 cm	2451	1970
200x200 cm	2778	1970
200x250 cm	3152	2470

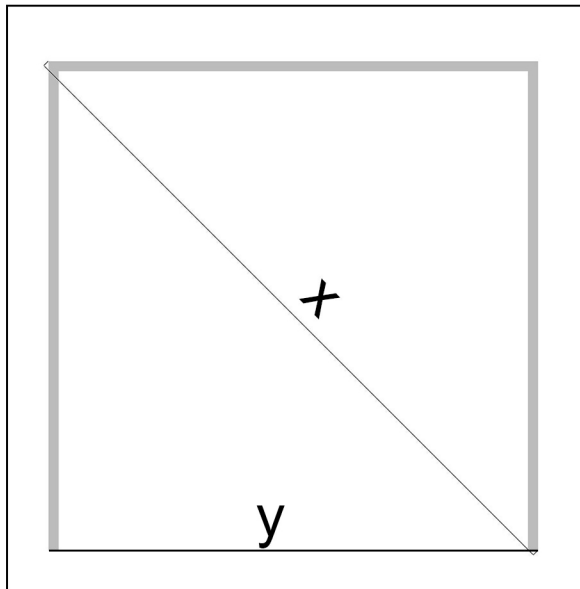
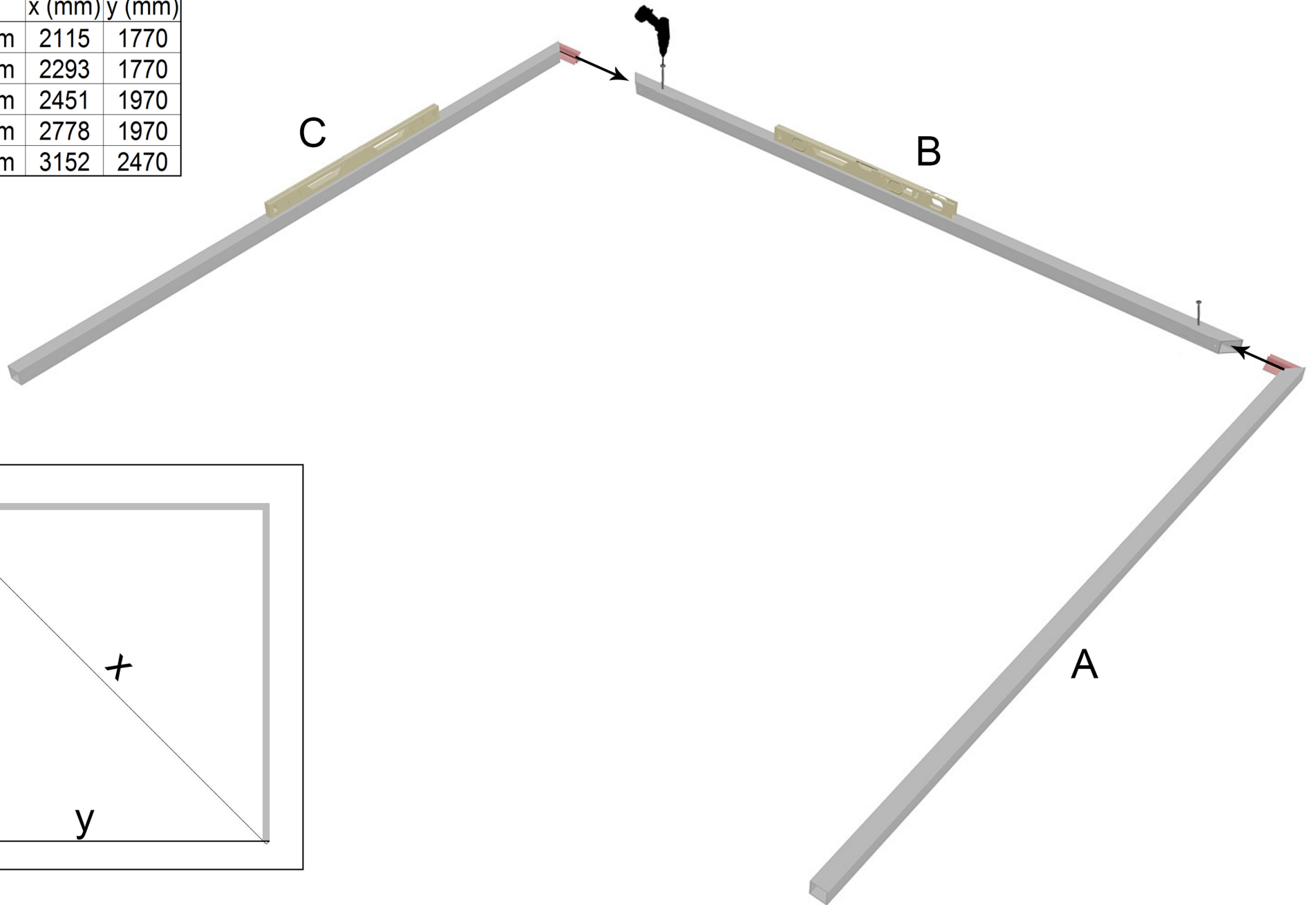

2. Walls

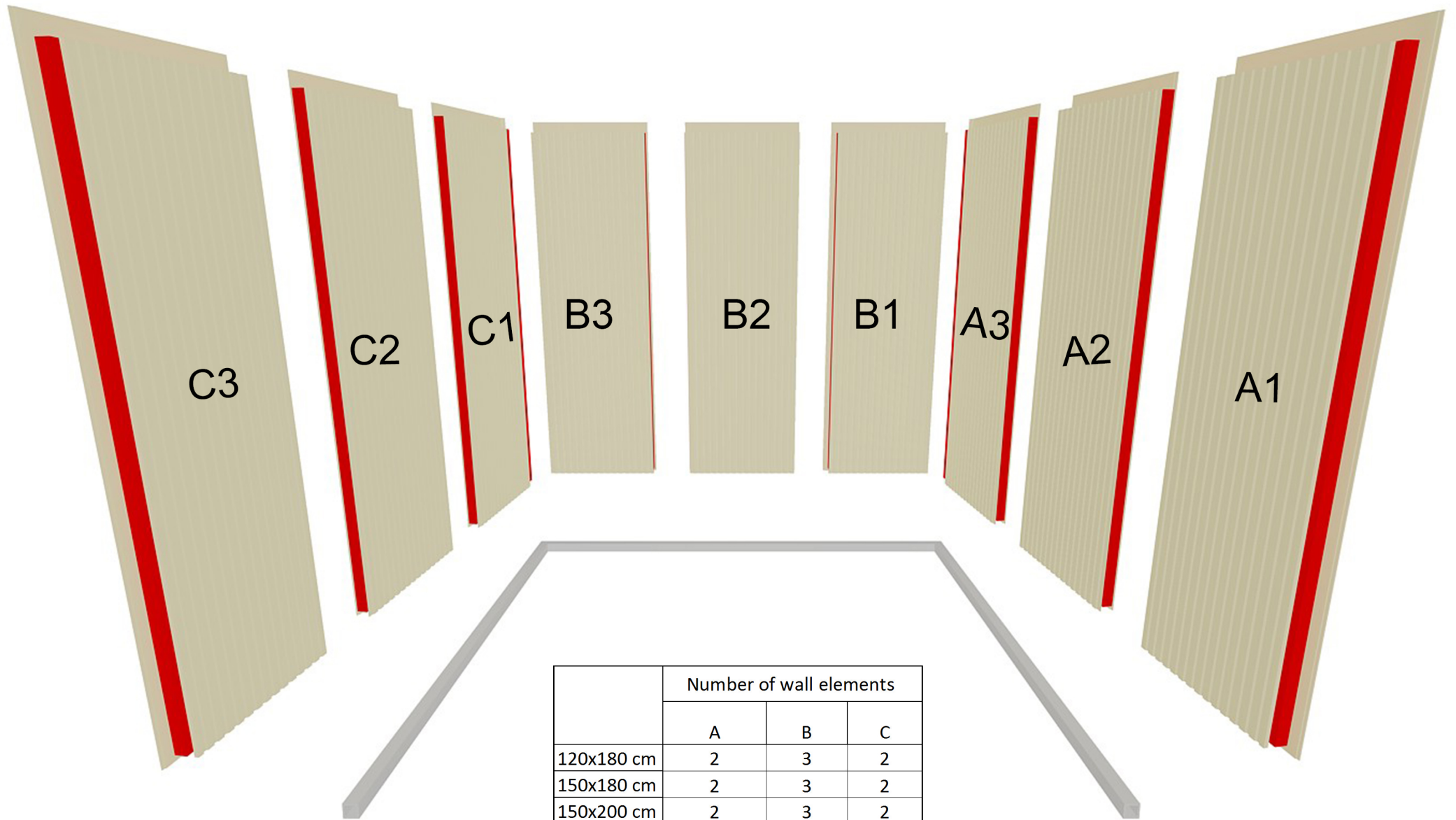

	Number of wall elements		
	A	B	C
120x180 cm	2	3	2
150x180 cm	2	3	2
150x200 cm	2	3	2
200x200 cm	3	3	3
200x250 cm	3	4	3

3. Multiclip closing system

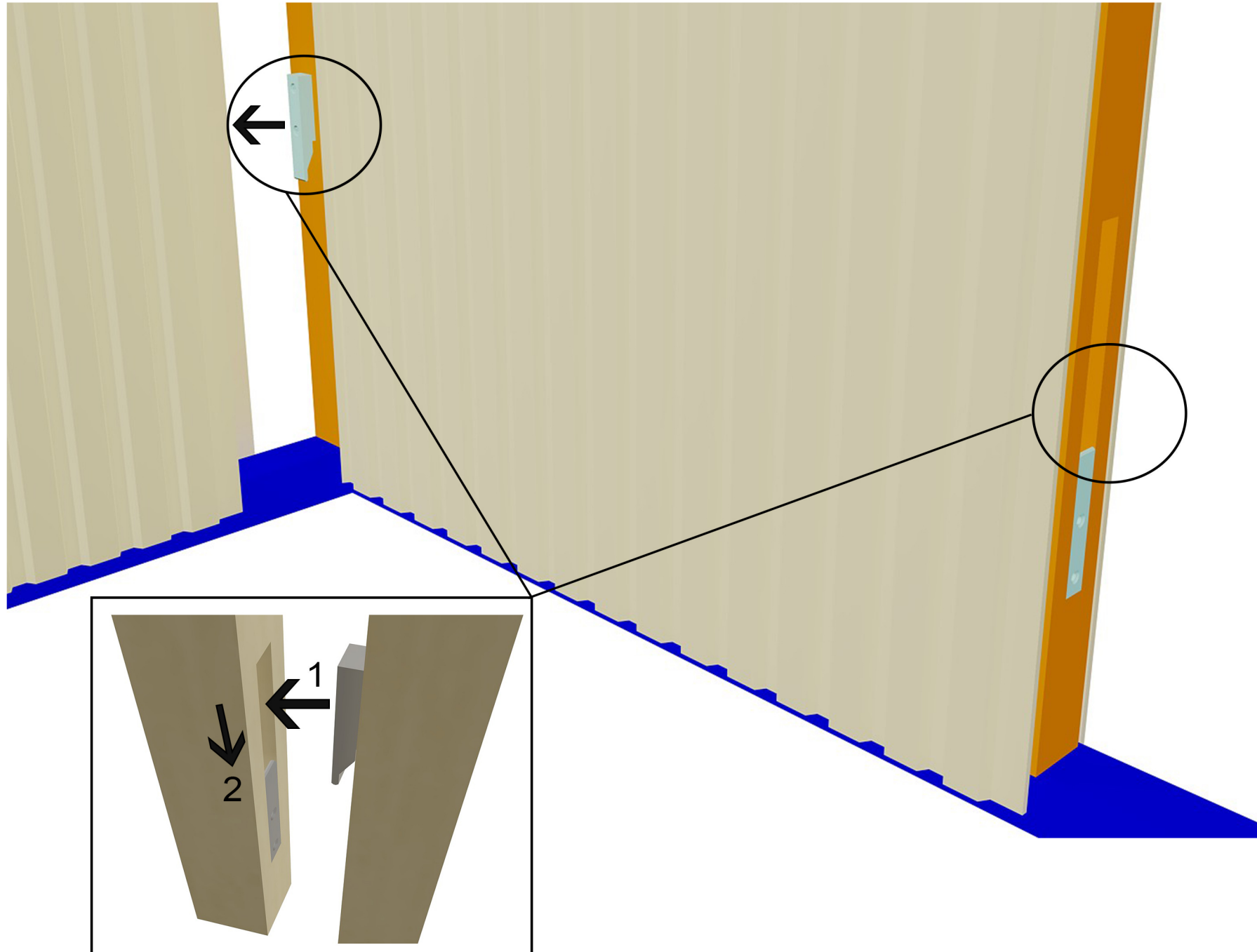

4. Fixing first corner walls

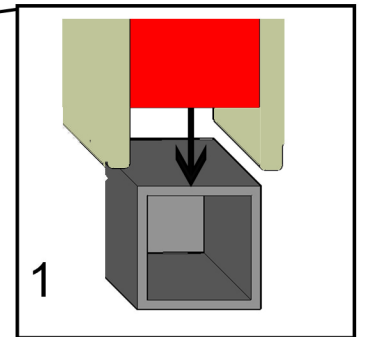
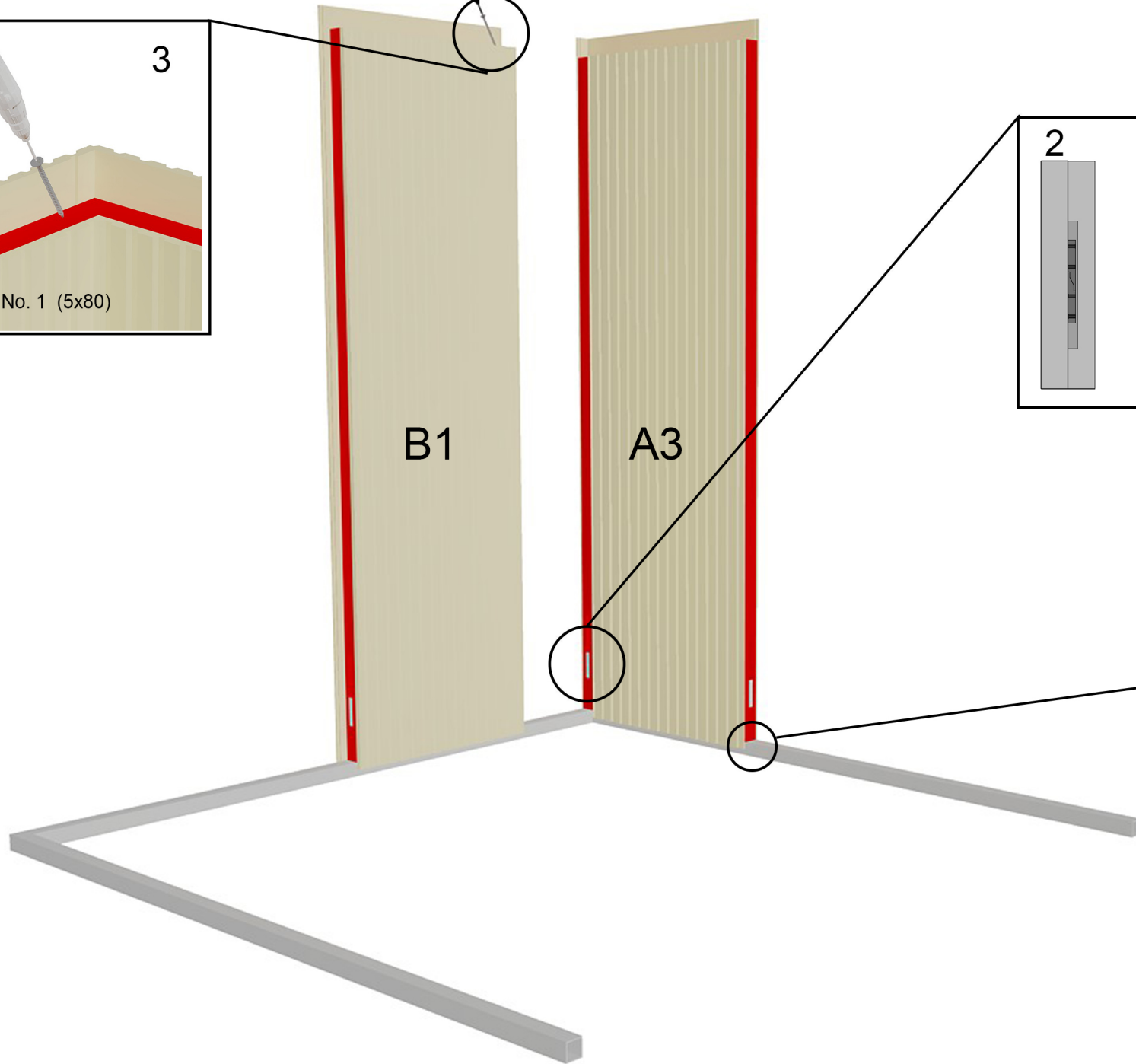
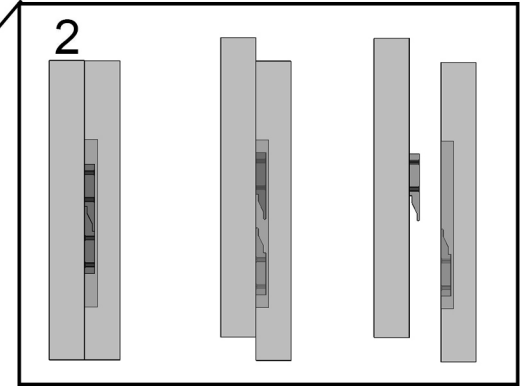
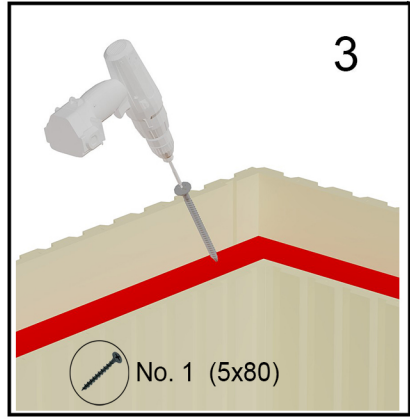

5. Fixing walls A1 & A2

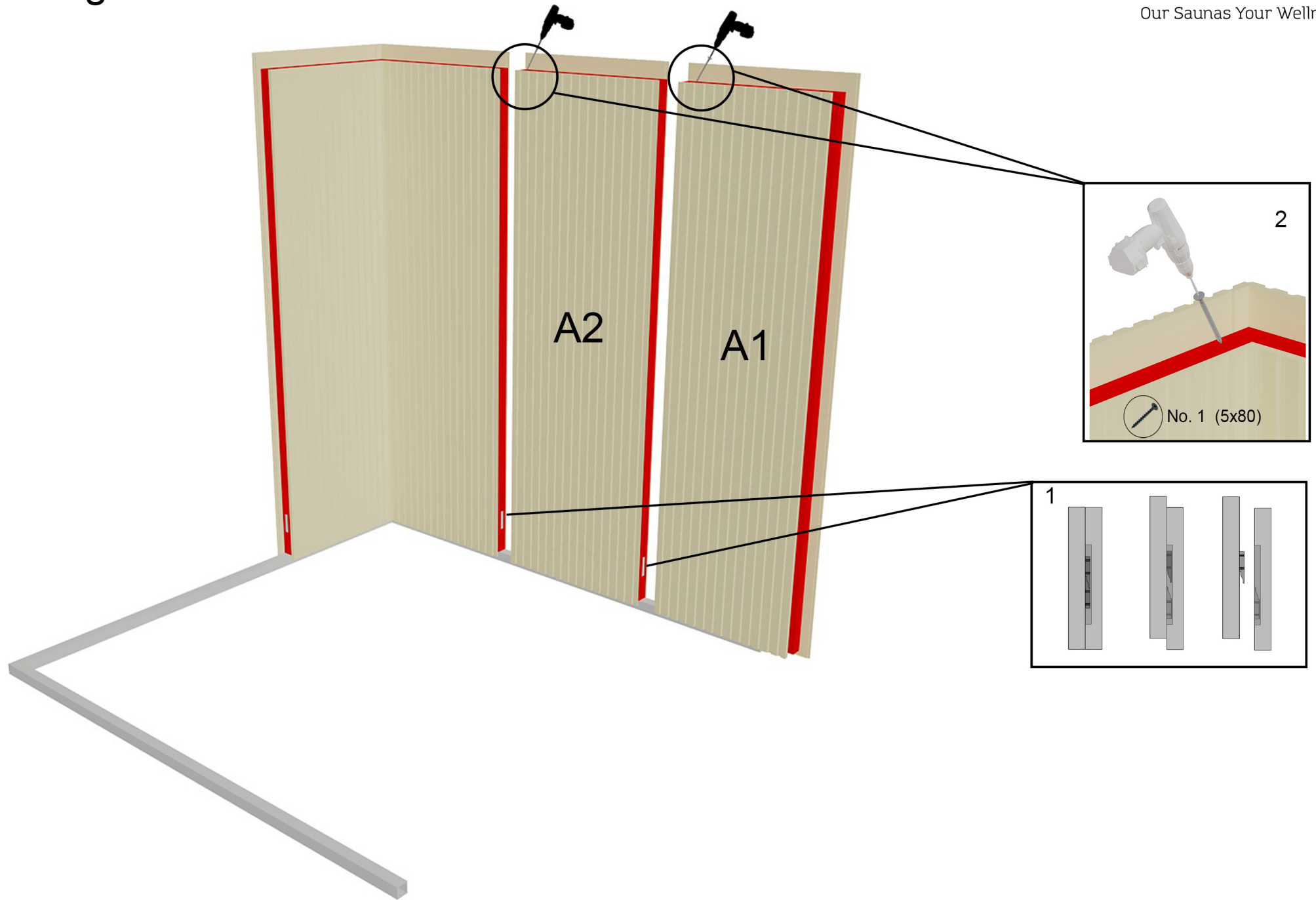

6. Fixing walls B2 & B3

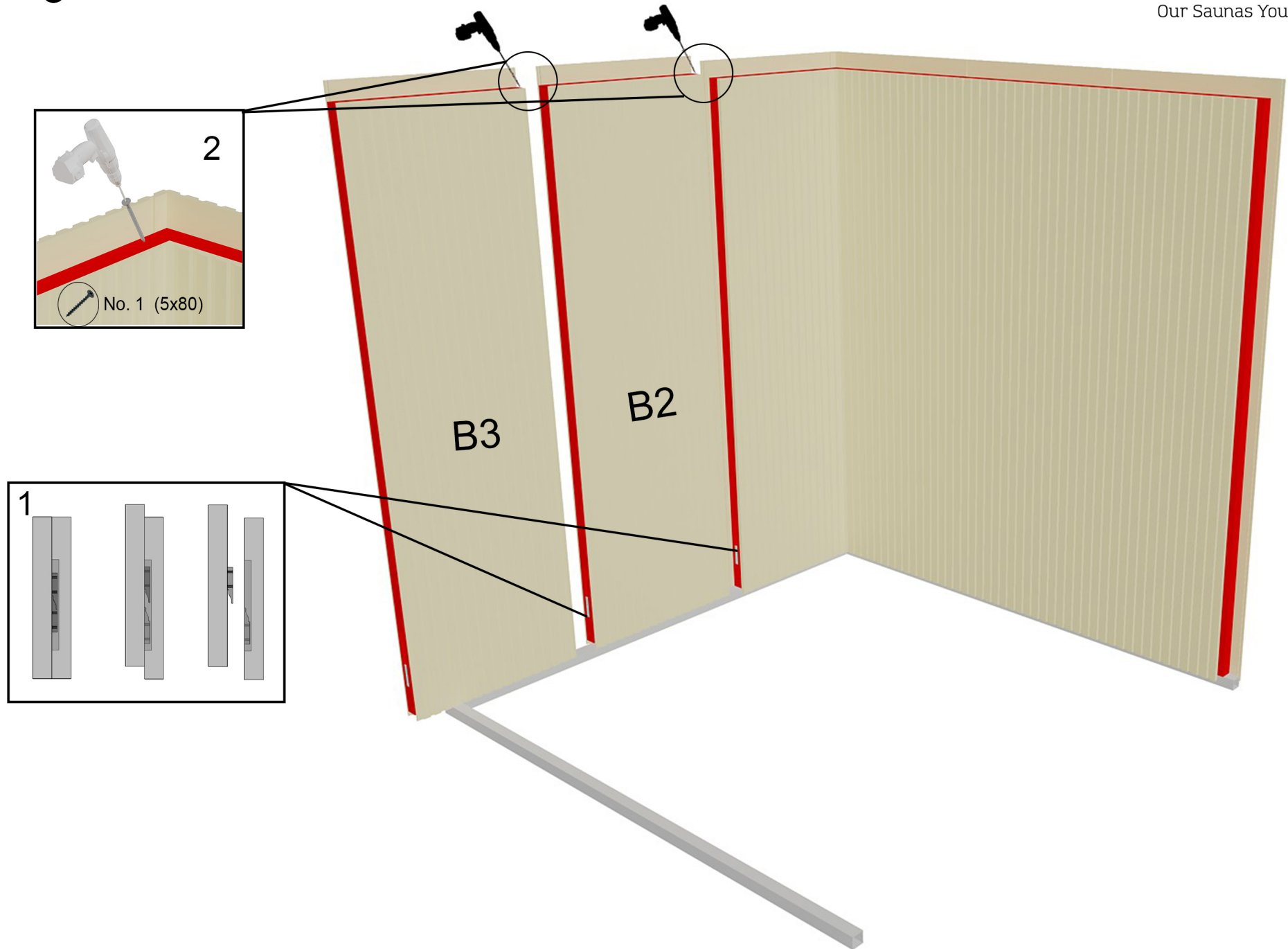

7. Fixing walls C1 & C2 & C3

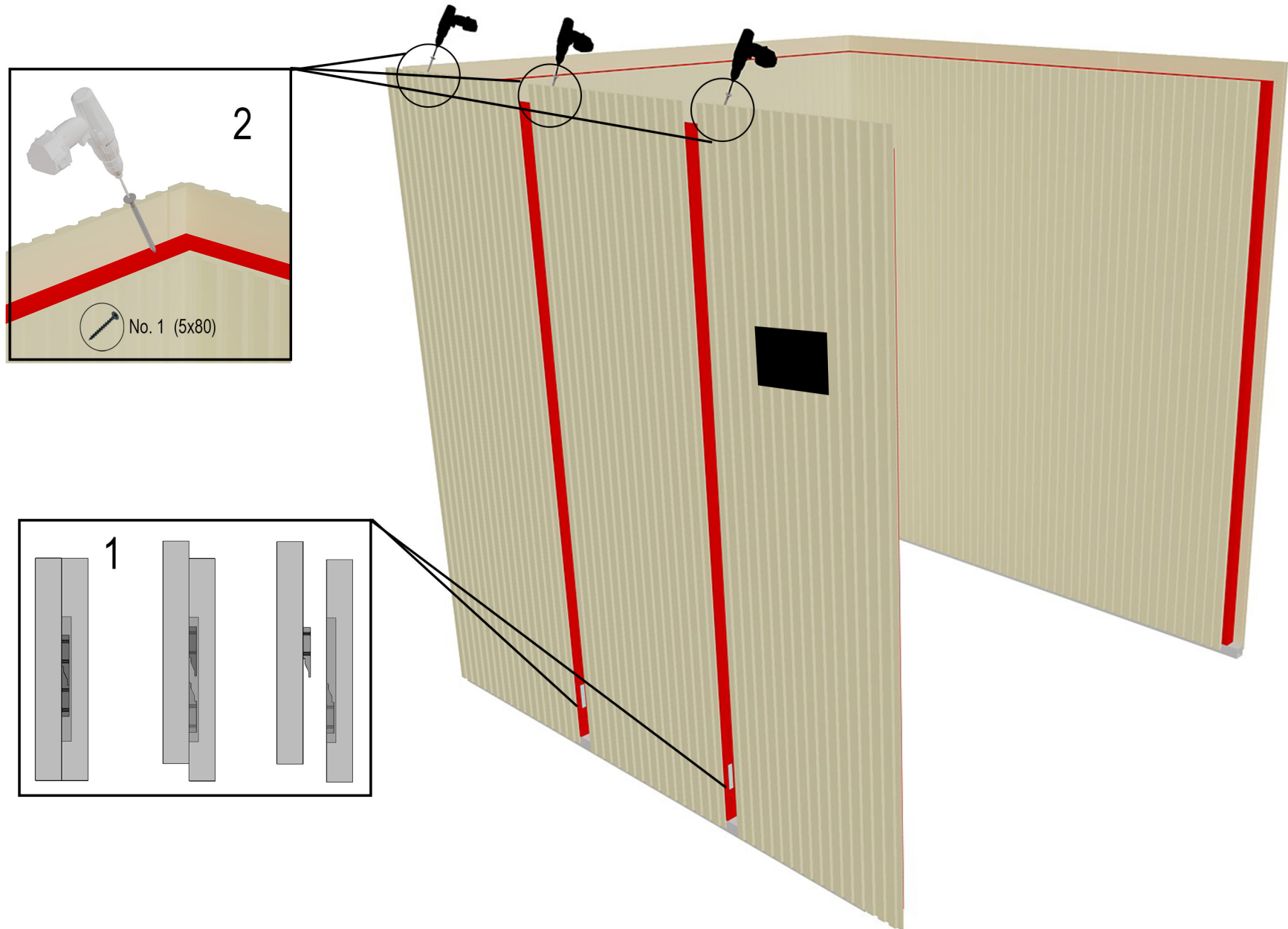

8. Fixing ceilings

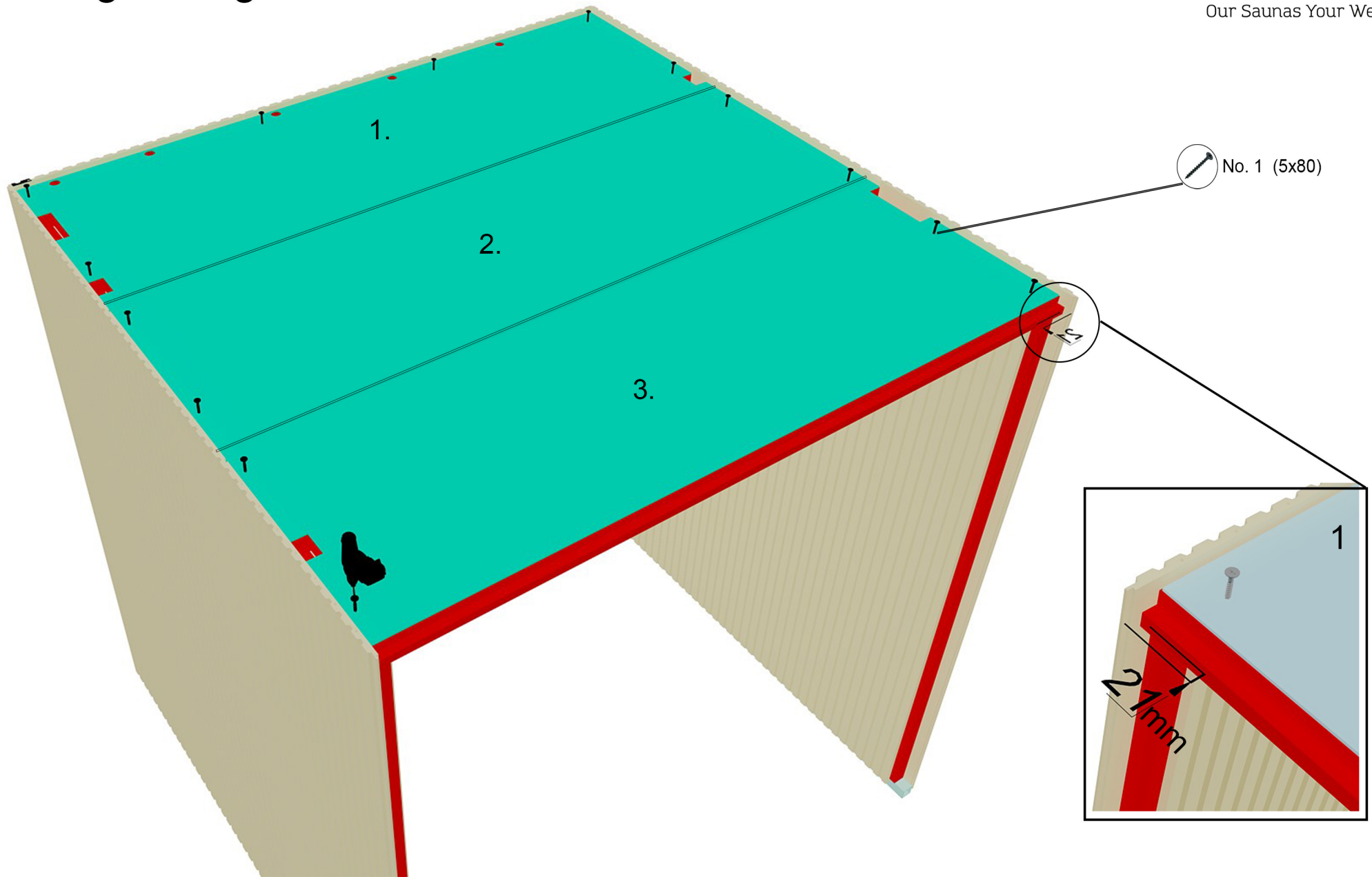

9. Interior 200x200 cm

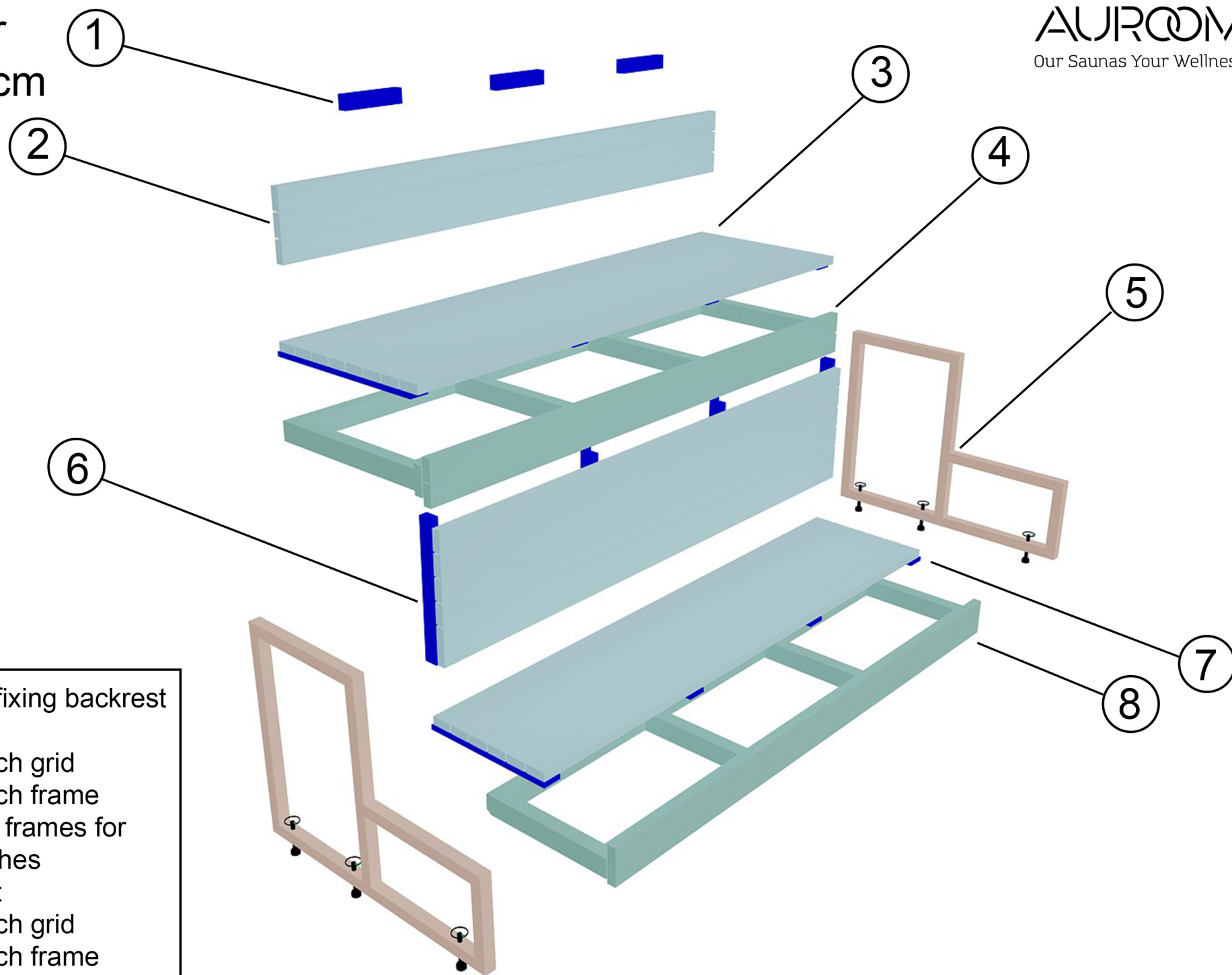

1. Blocks for fixing backrest
2. Backrest
3. Upper bench grid
4. Upper bench frame
5. Assistance frames for fixing benches
6. Bench skirt
7. Lower bench grid
8. Lower bench frame

9.1 Interior

120x180 cm
150x180 cm
150x200 cm

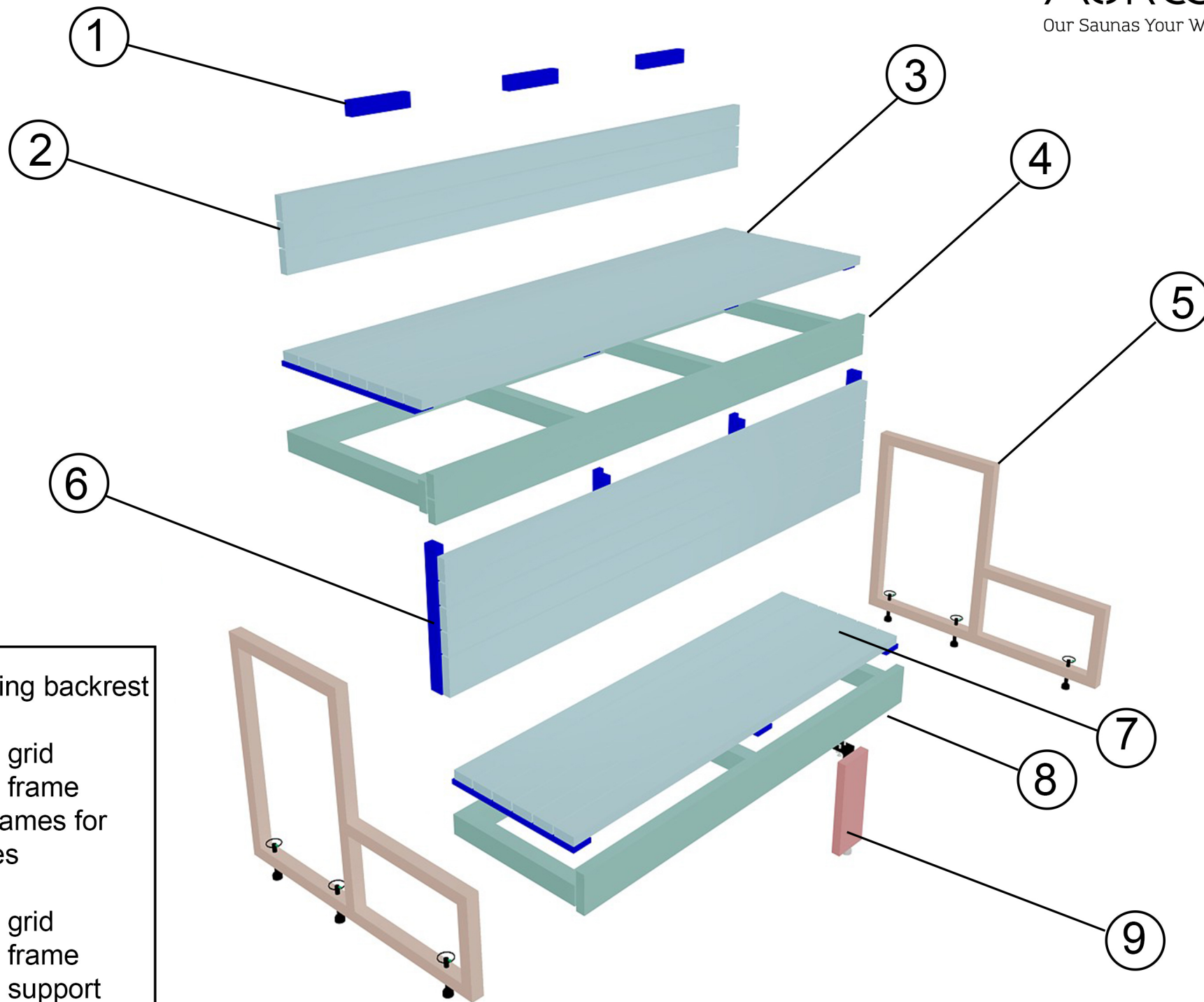

- 1. Blocks for fixing backrest
- 2. Backrest
- 3. Upper bench grid
- 4. Upper bench frame
- 5. Assistance frames for fixing benches
- 6. Bench skirt
- 7. Lower bench grid
- 8. Lower bench frame
- 9. Lower bench support

9.2 Interior 200x250 cm

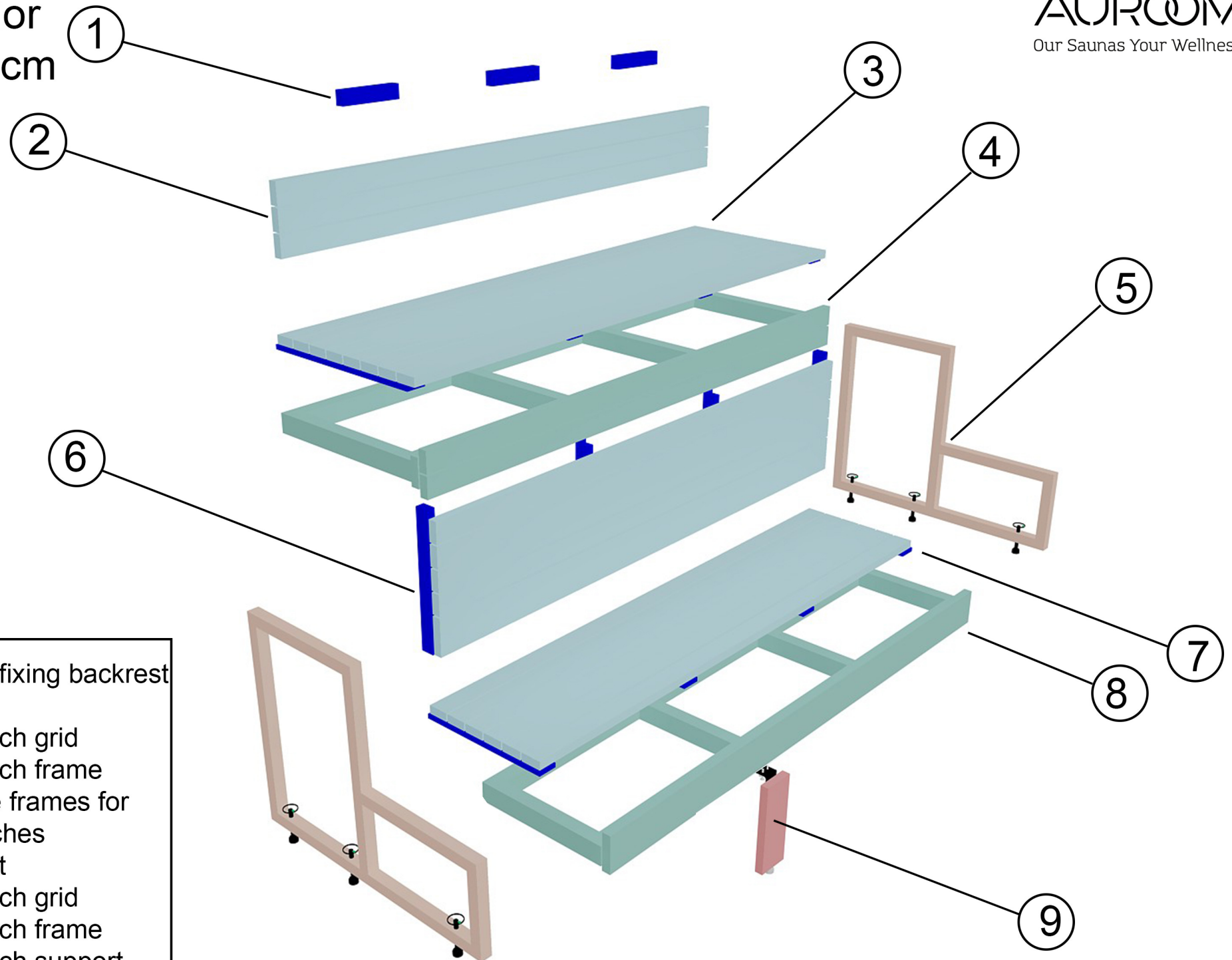

1. Blocks for fixing backrest
2. Backrest
3. Upper bench grid
4. Upper bench frame
5. Assistance frames for fixing benches
6. Bench skirt
7. Lower bench grid
8. Lower bench frame
9. Lower bench support

10. Assistance frames

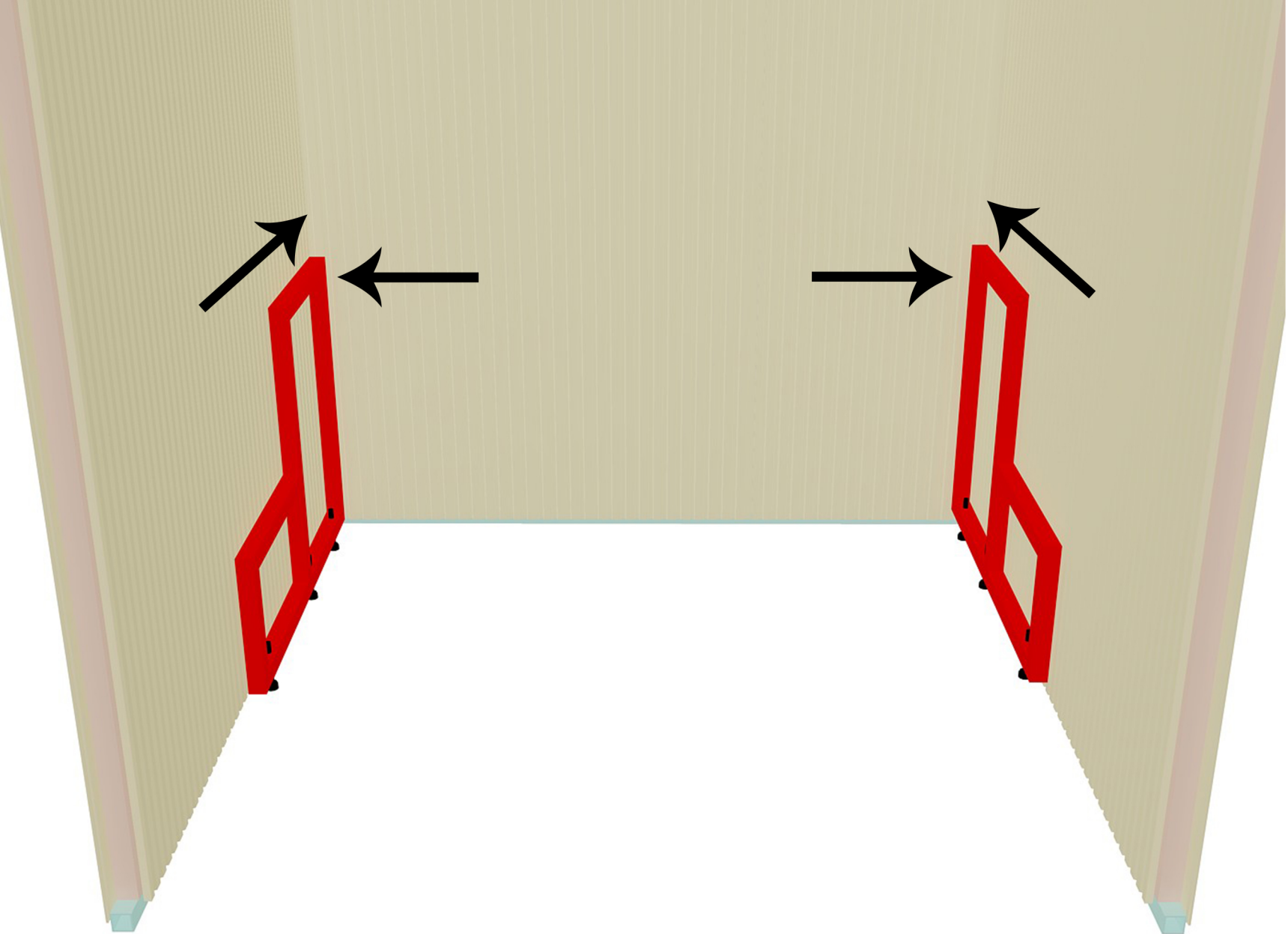

11. Bench support installing

120x180 cm

150x180 cm

150x200 cm

200x250 cm

Pre-marked stripes

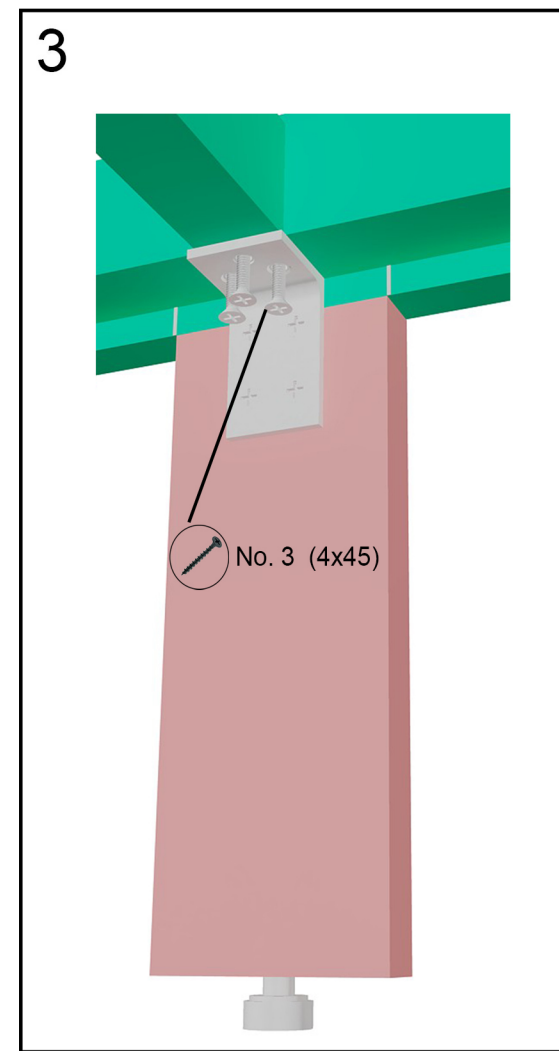
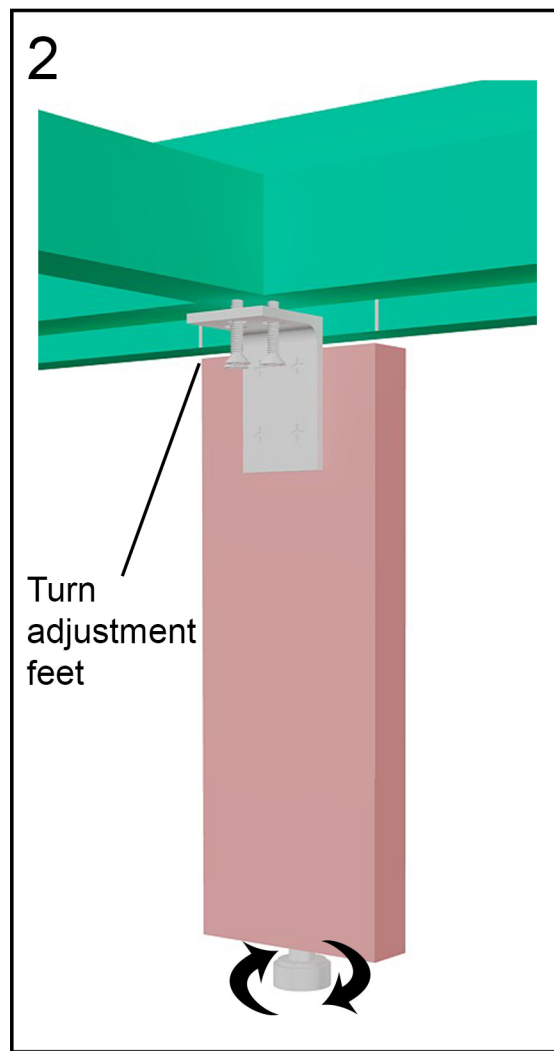
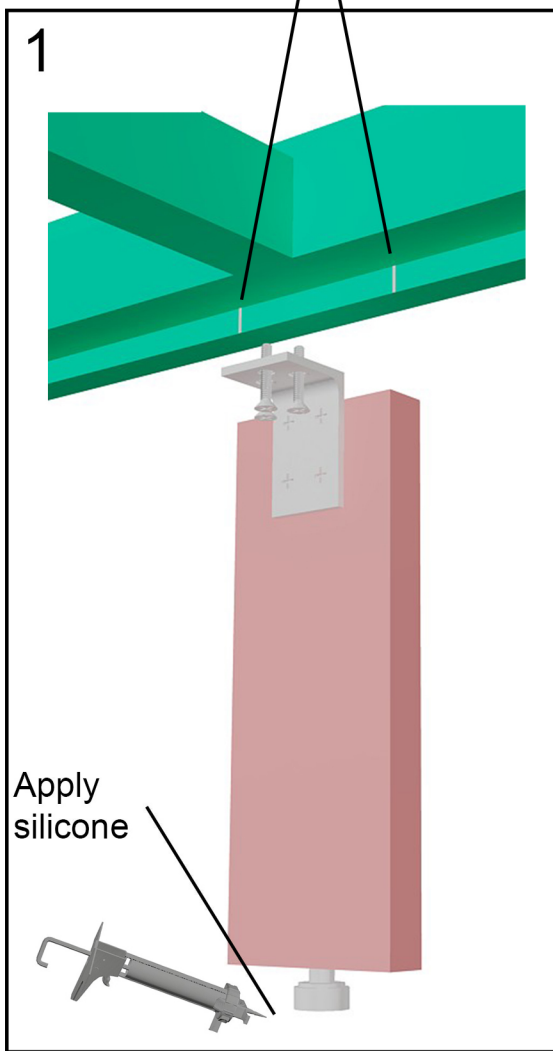

12. Bench frames and backrest blocks fixing 200x200 cm

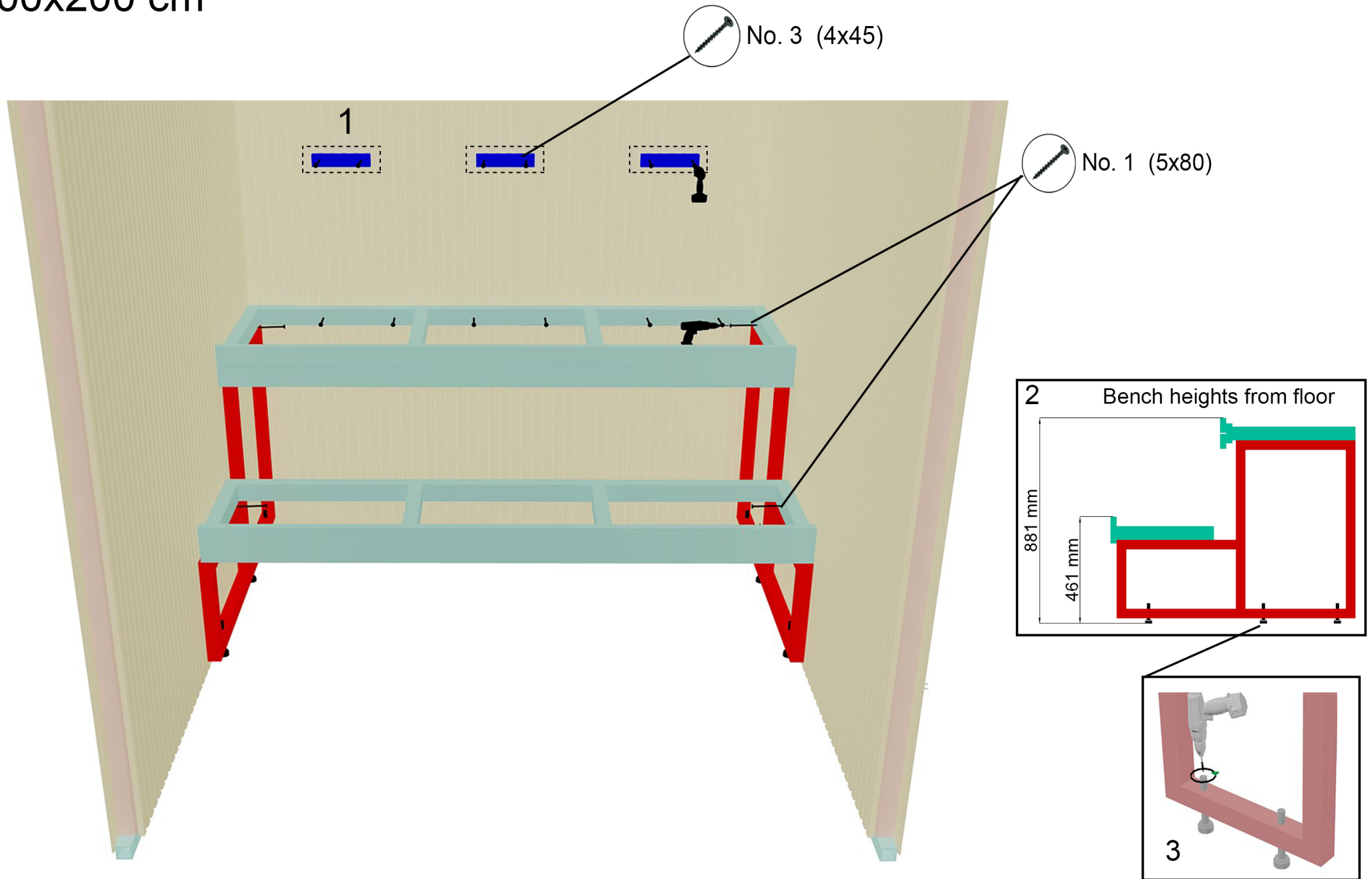

12.1 Bench frames and backrest blocks fixing

120x180 cm

150x180 cm

150x200 cm

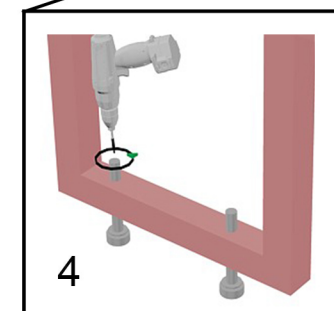
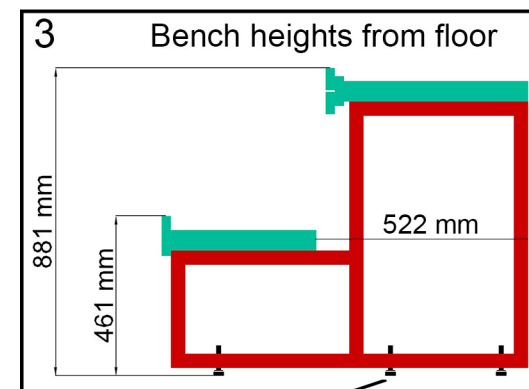
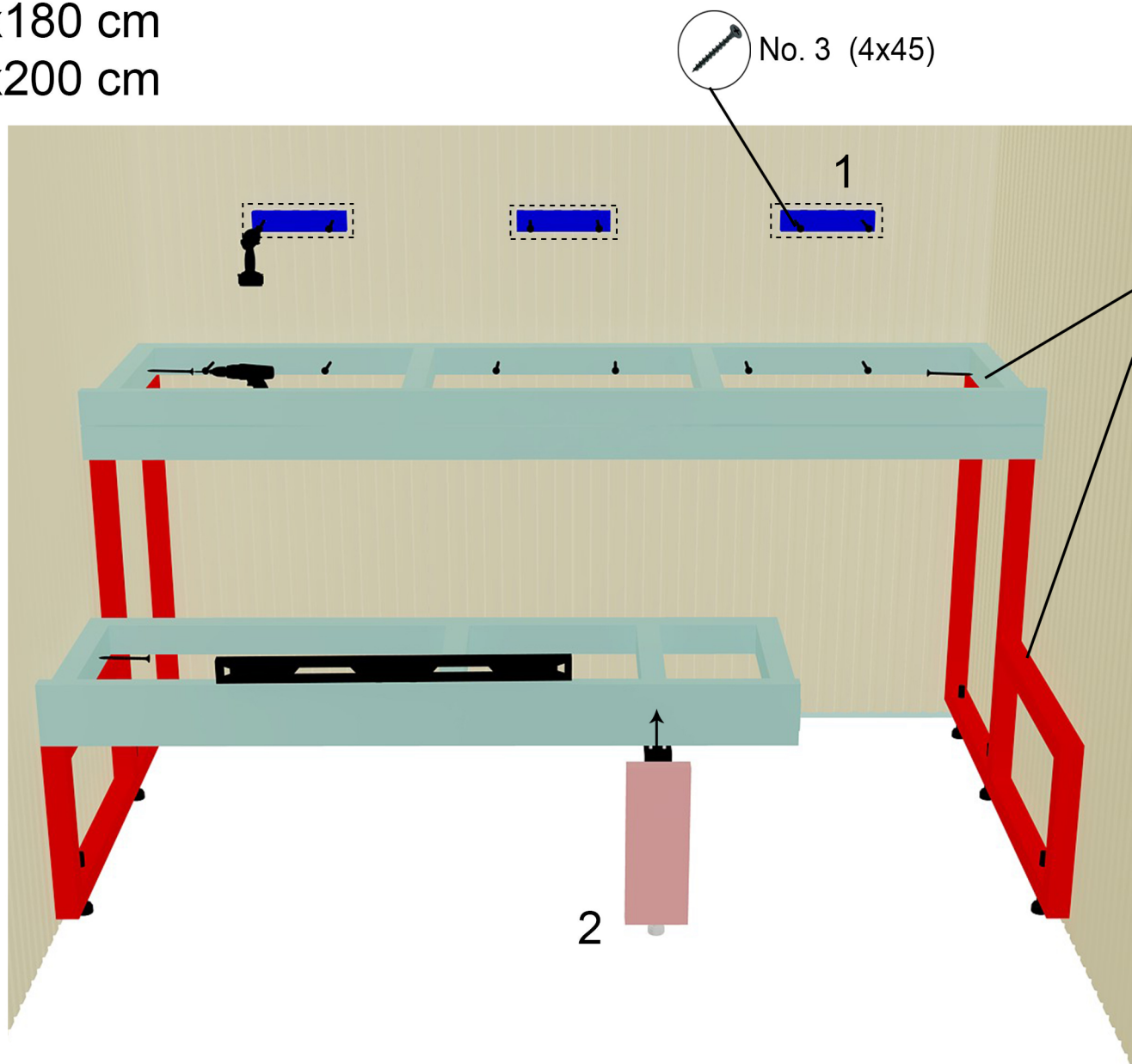

12.2 Bench frames and backrest blocks fixing 200x250 cm

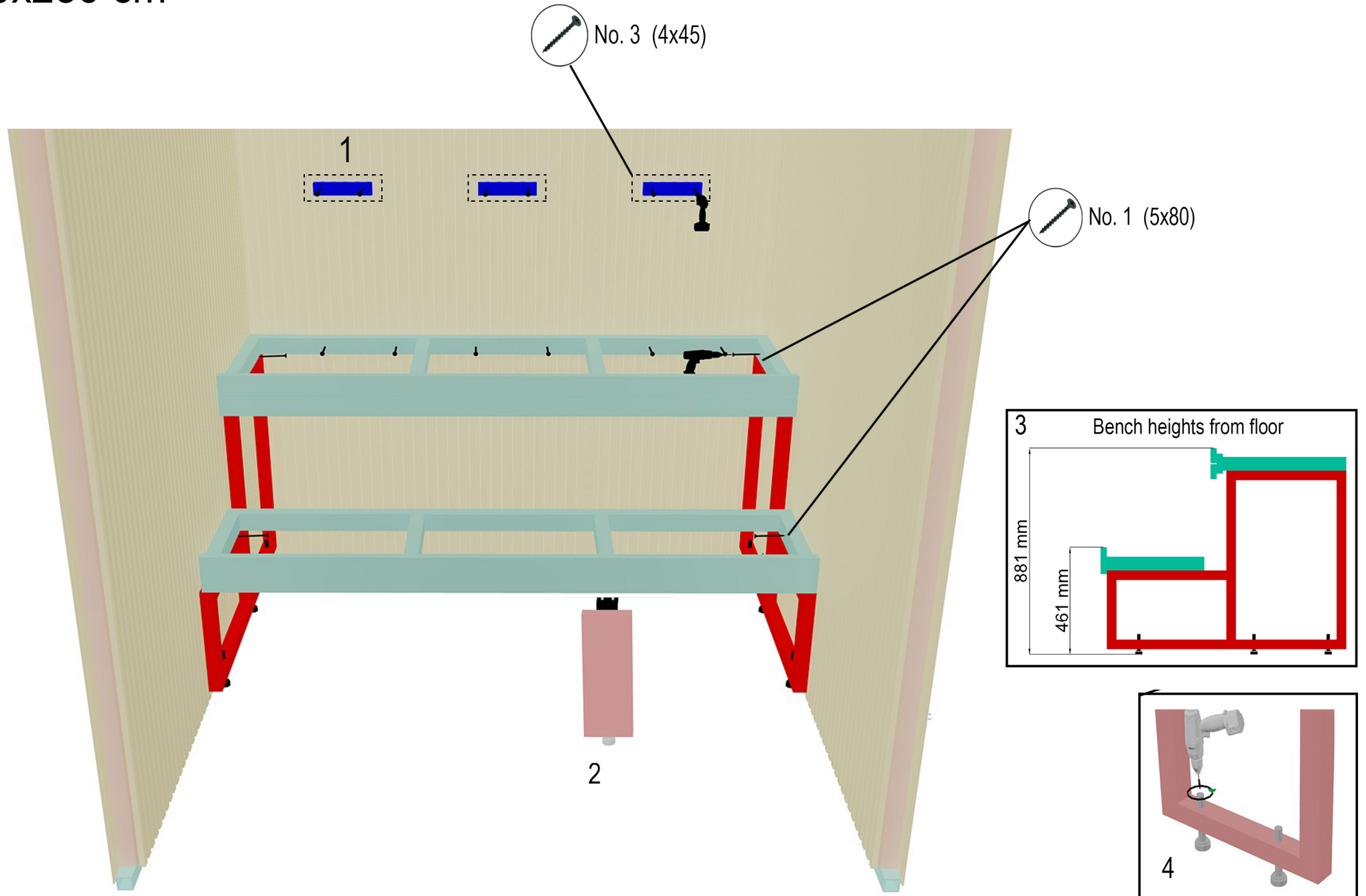

13. Removing assistance frames

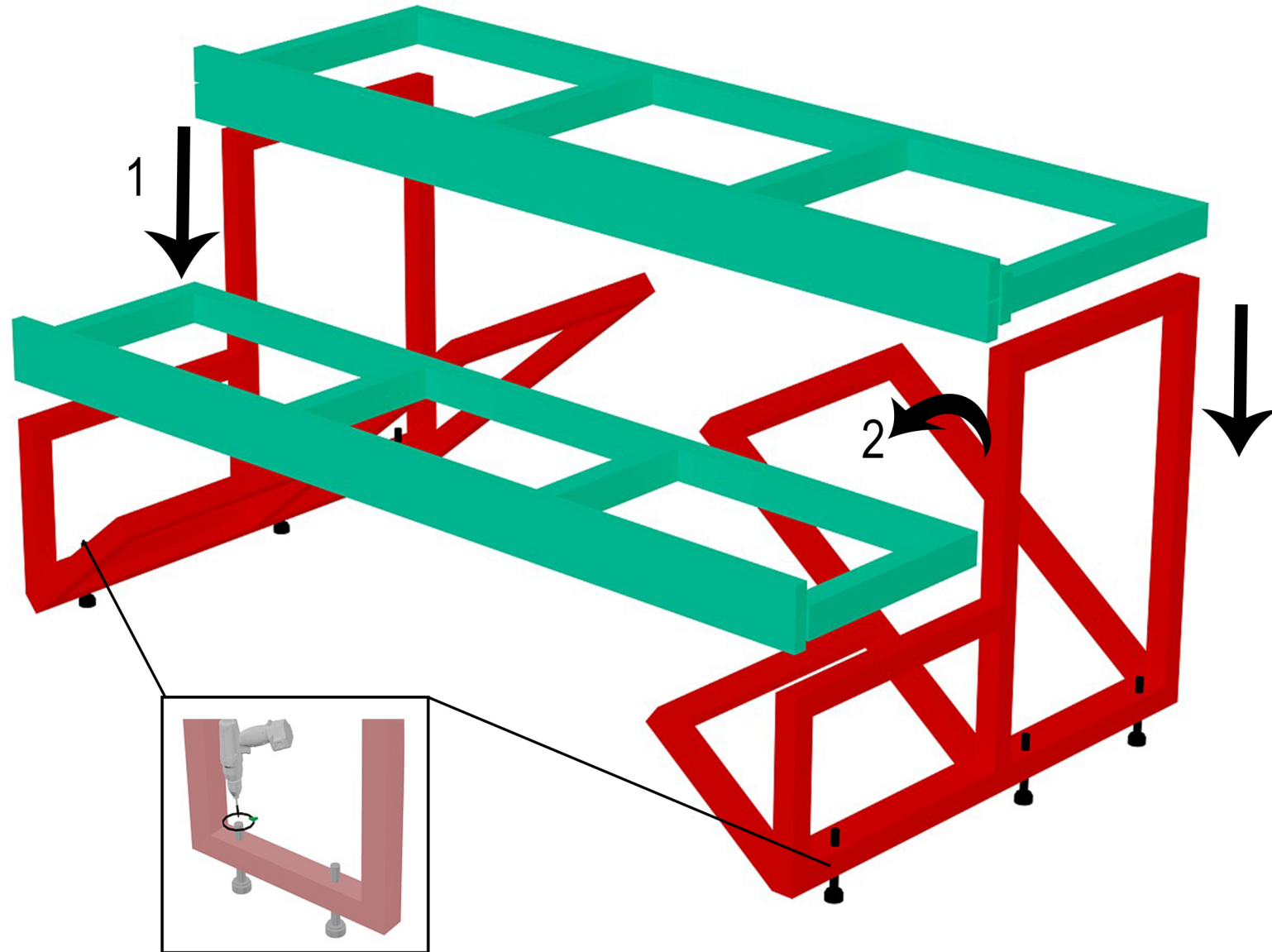

14. Wiring inside walls

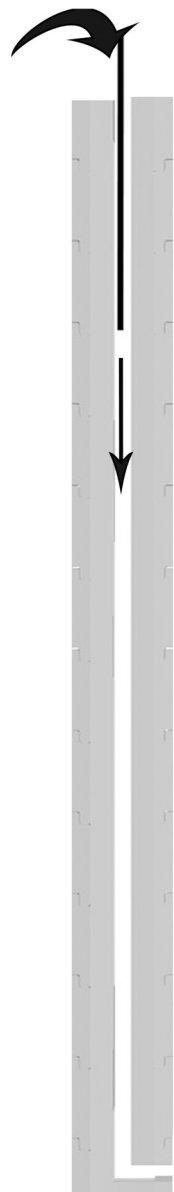

1. Push down wires from precut holes on ceiling

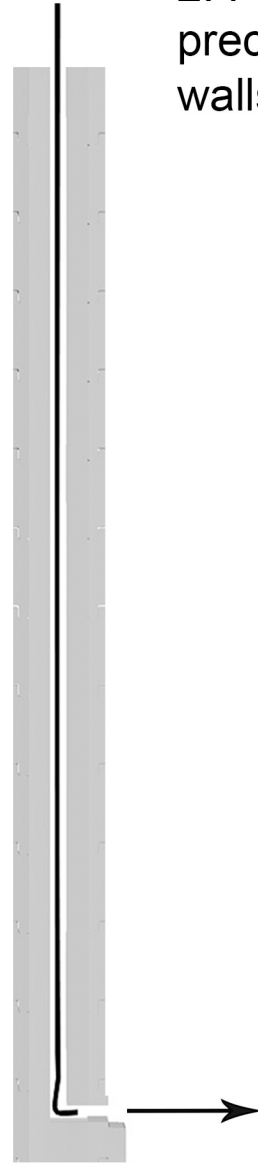

2. Pull out wires from precut holes in the walls

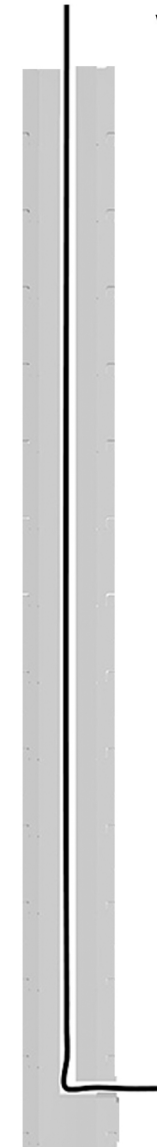

3. Connect wires

15. Connecting LED-strips

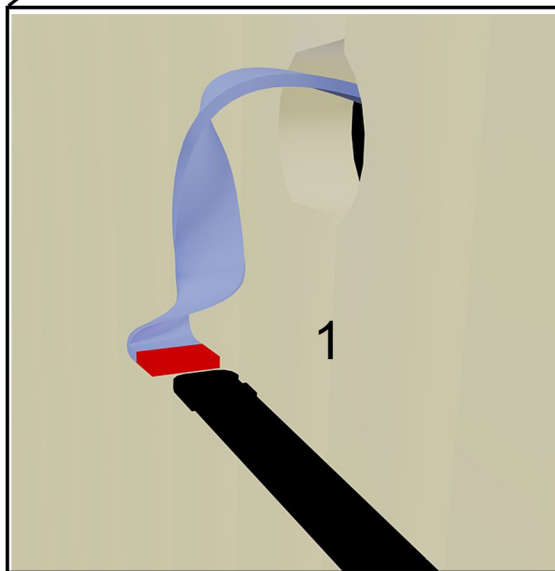
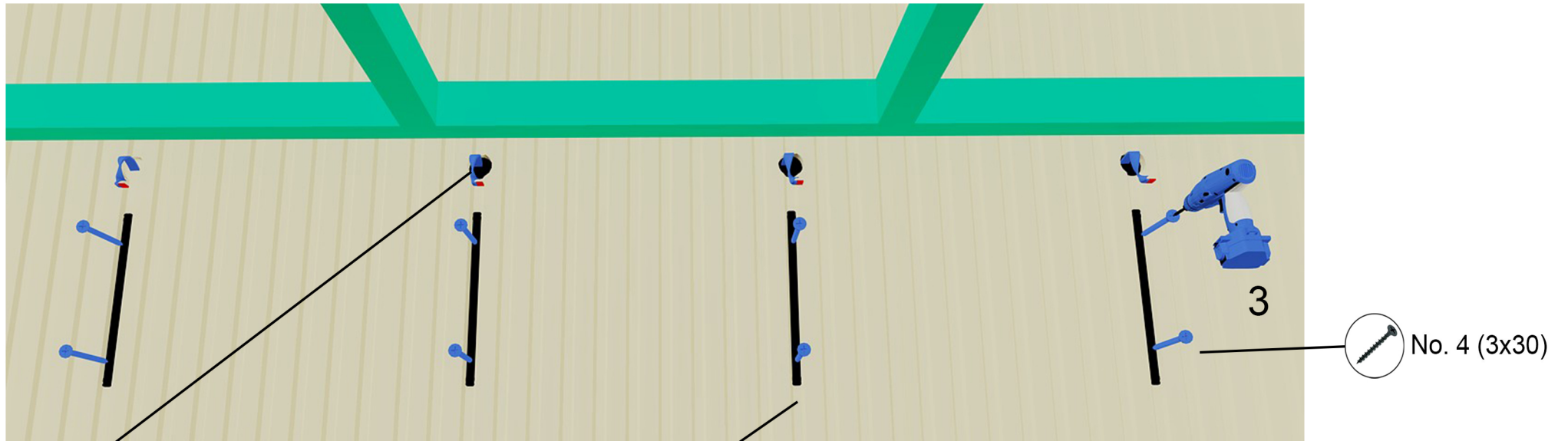

! Always use certified electrician

16. Fixing bench skirt

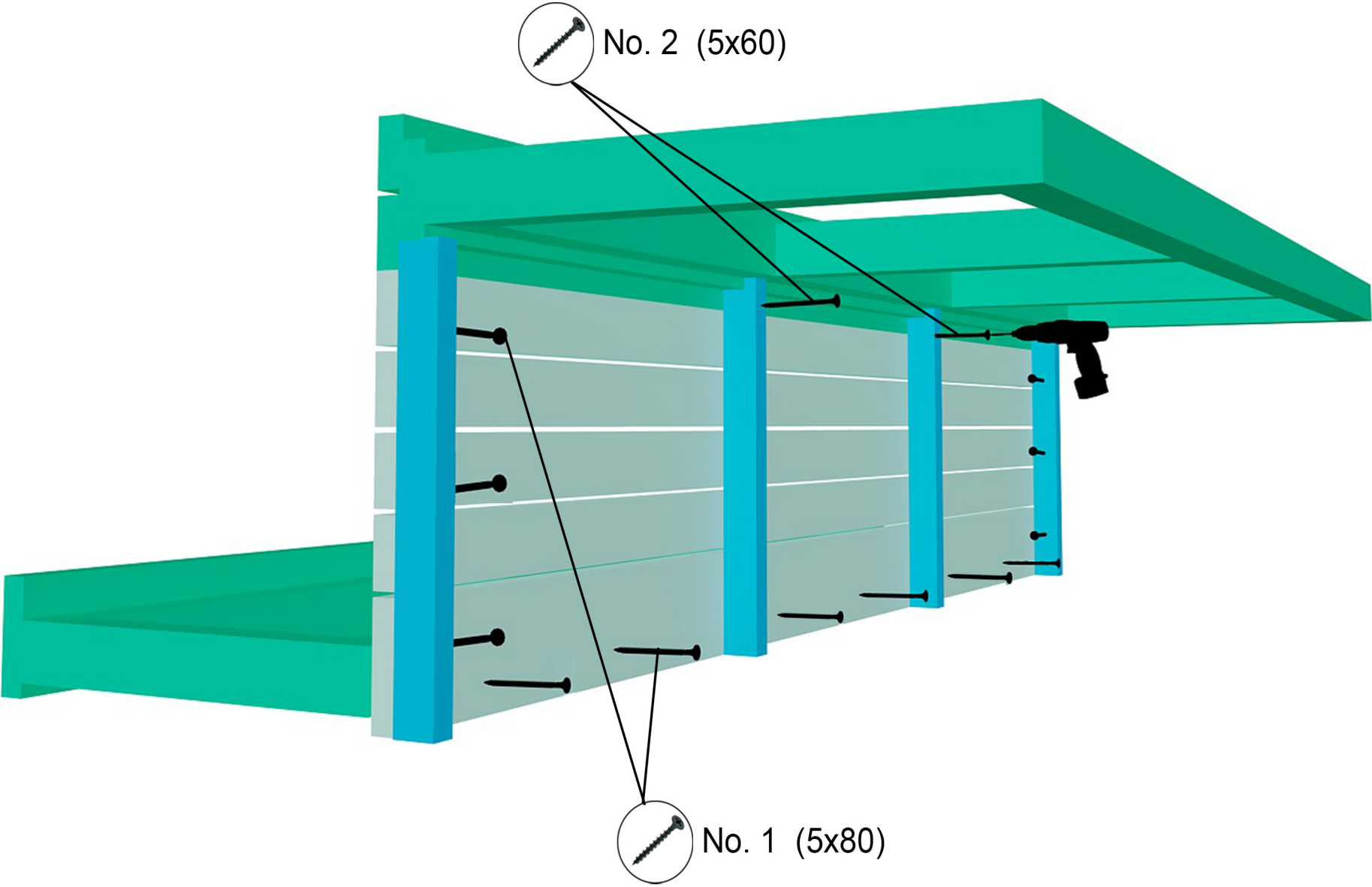

17. Backrest & bench grids

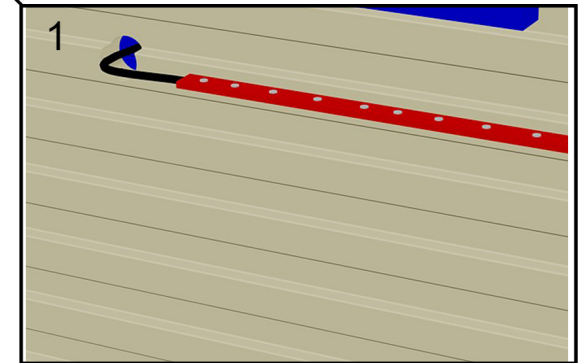
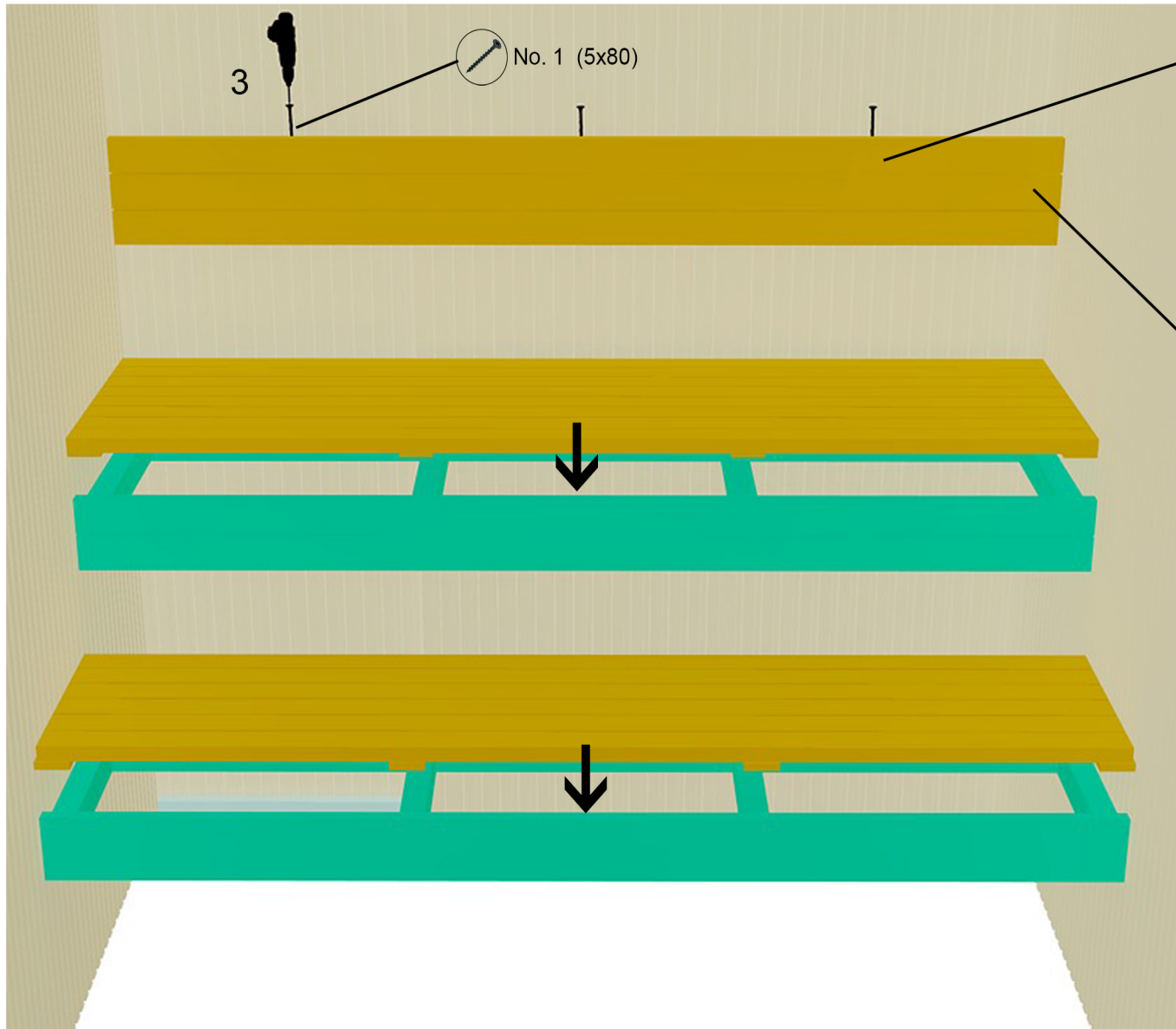

1. Push LED-strip cable to ceiling for connection
4. Fix LED-strip on top of backrest with glue (covering screws)

18. Interior II

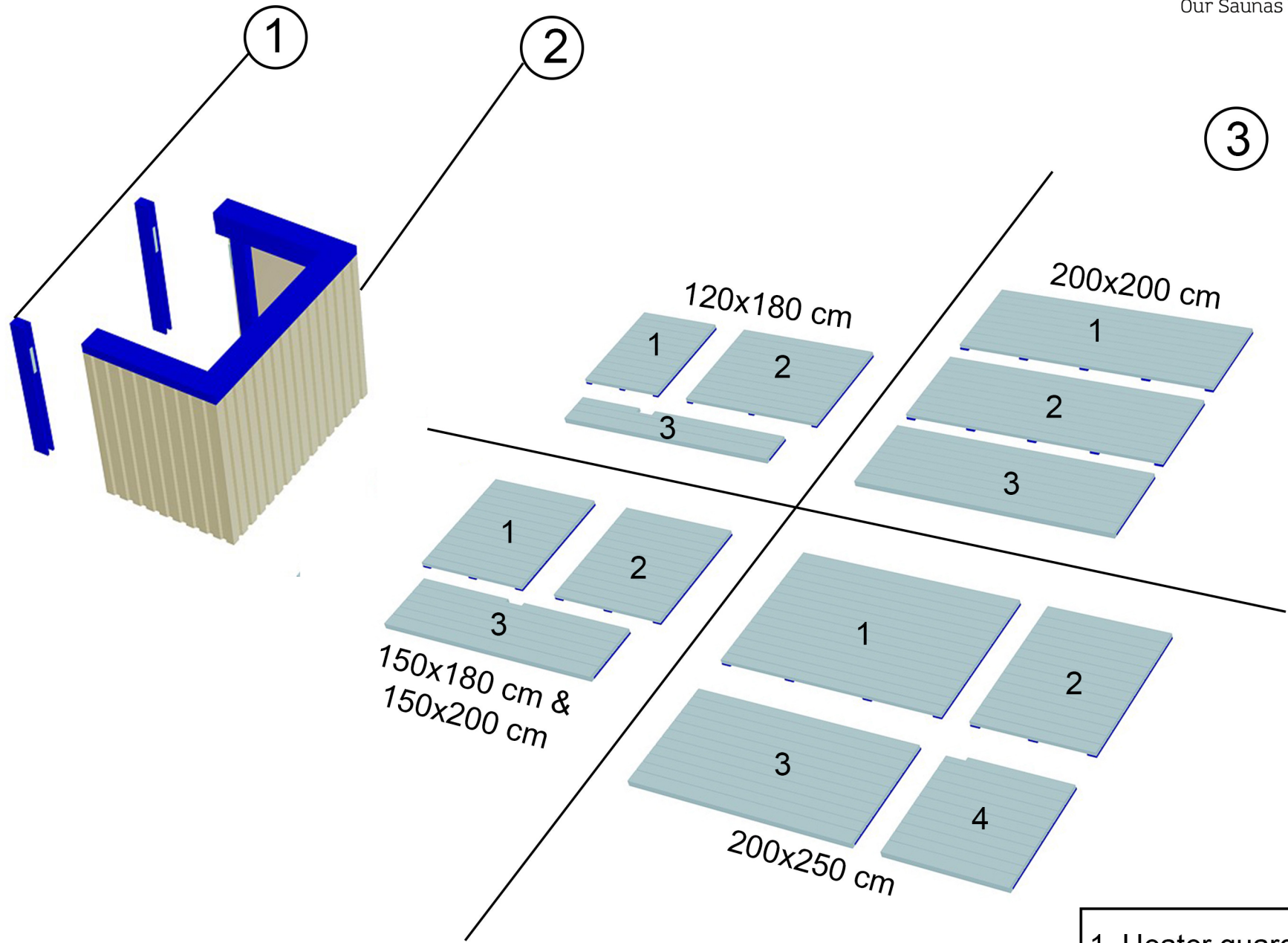

- 1. Heater guard holders
- 2. Heater guard
- 3. Floor grids

19. Heater guard

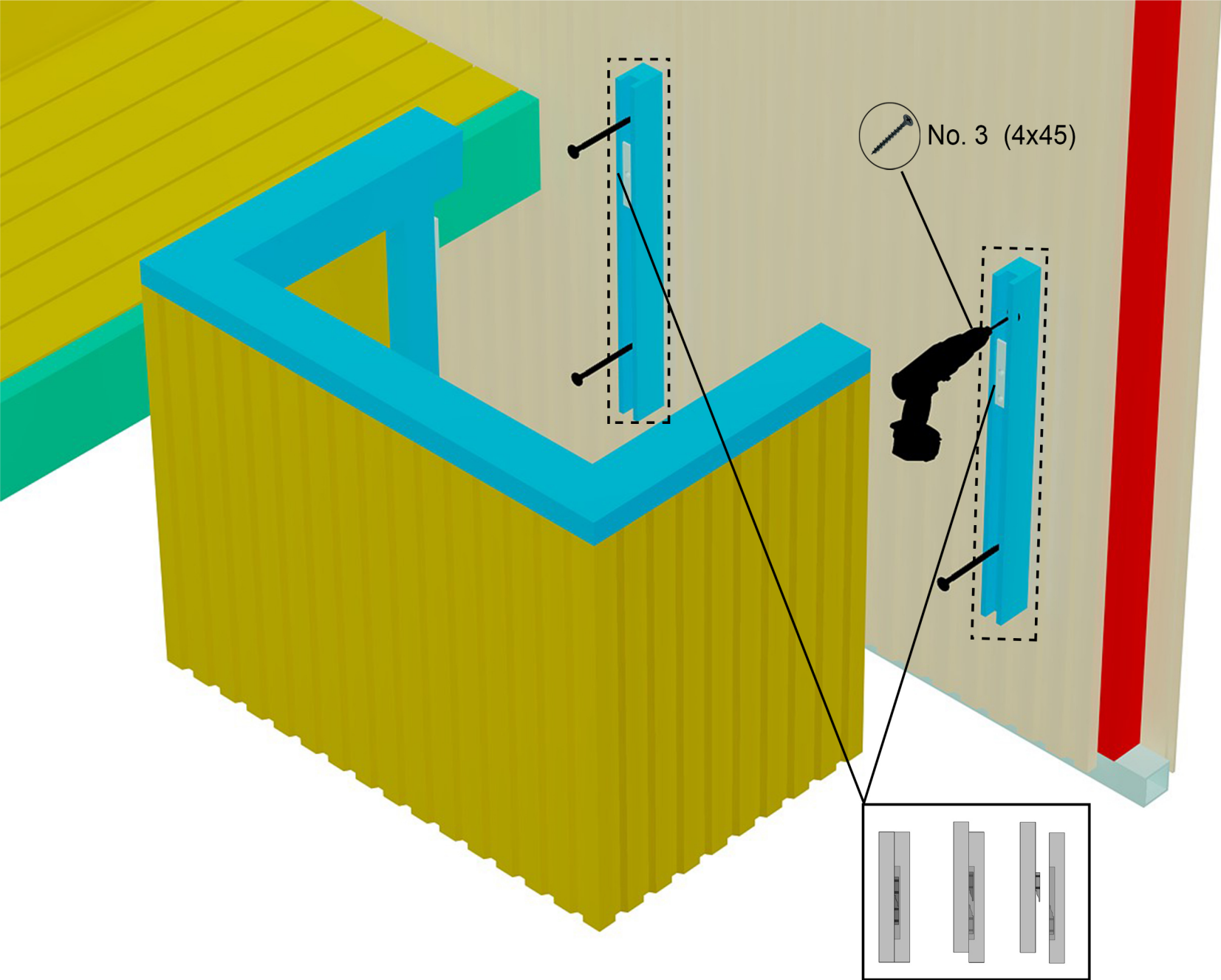

20. Glass wall and door frame

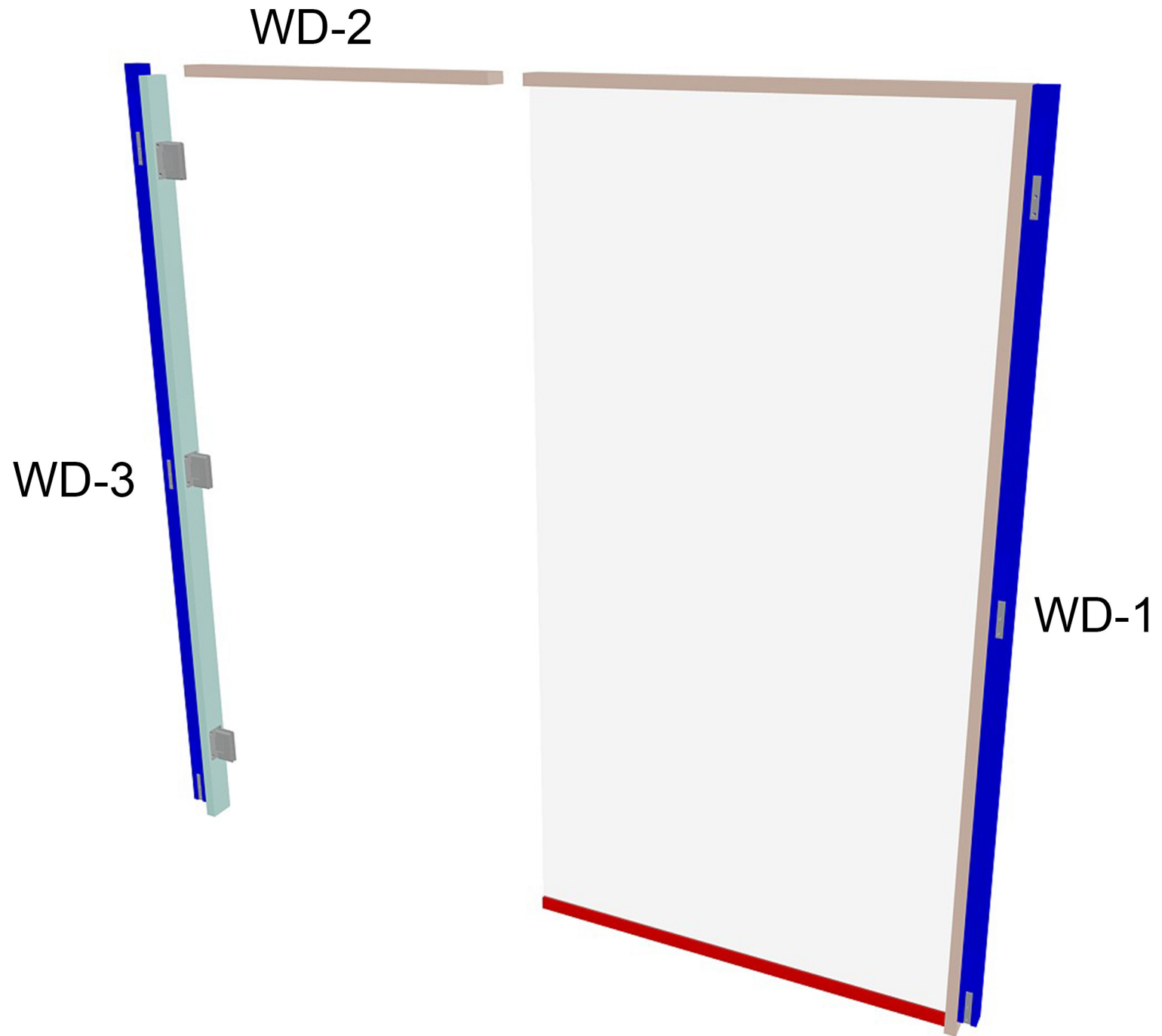

21. Aluminium profile fixing under glass wall

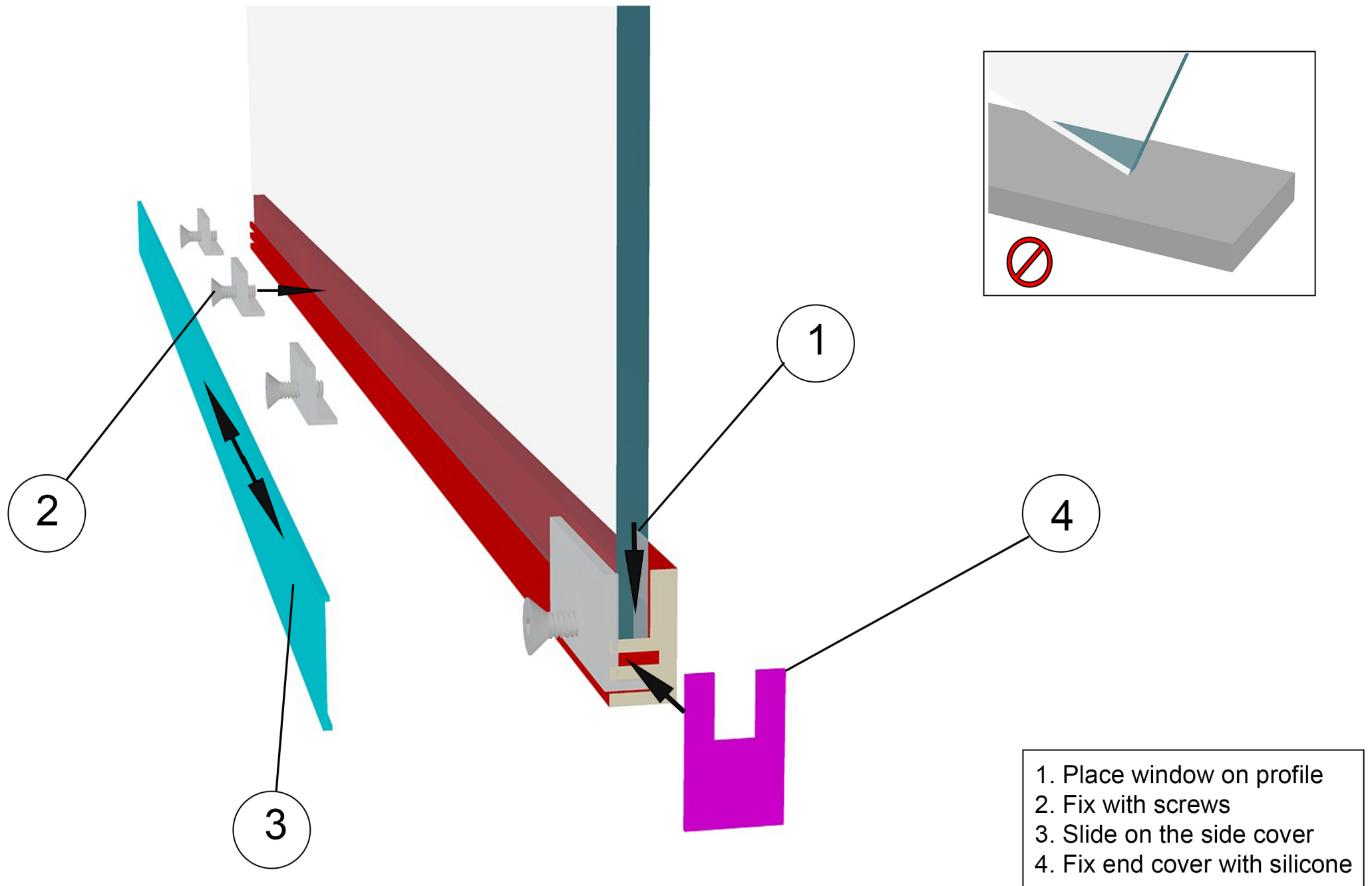

22. Fixing glass wall frame

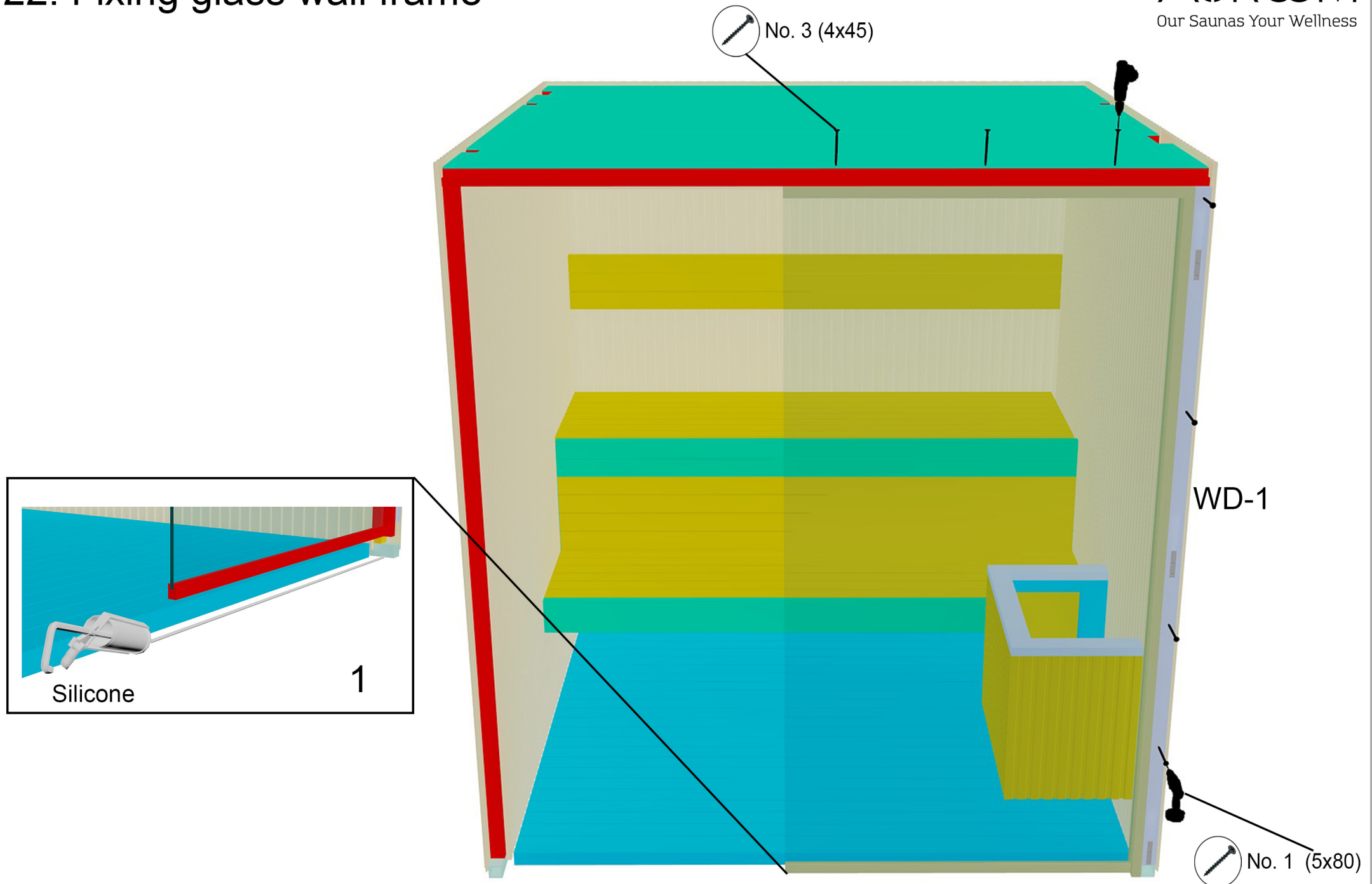

23. Fixing door frame

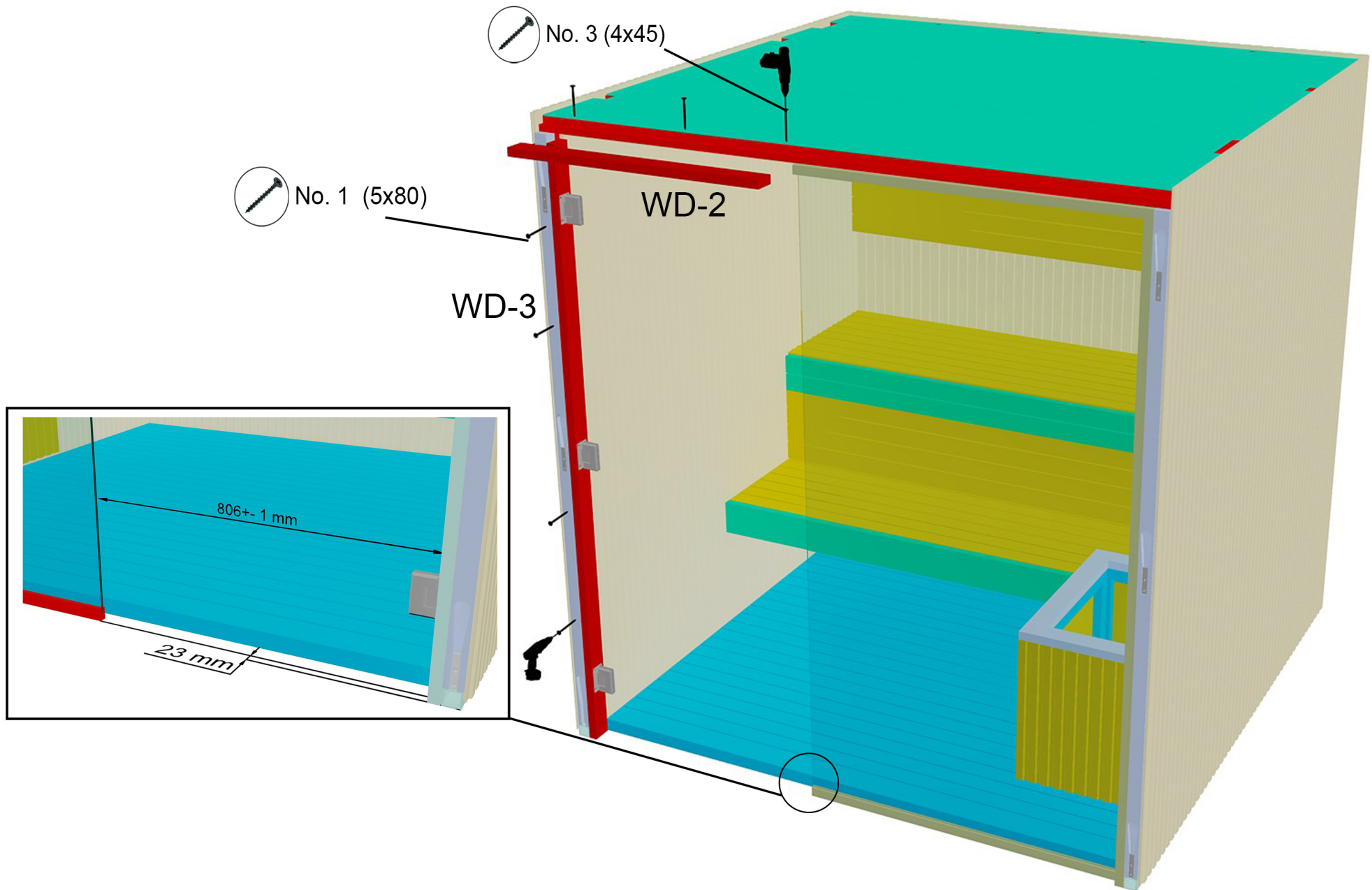

24. Front frame

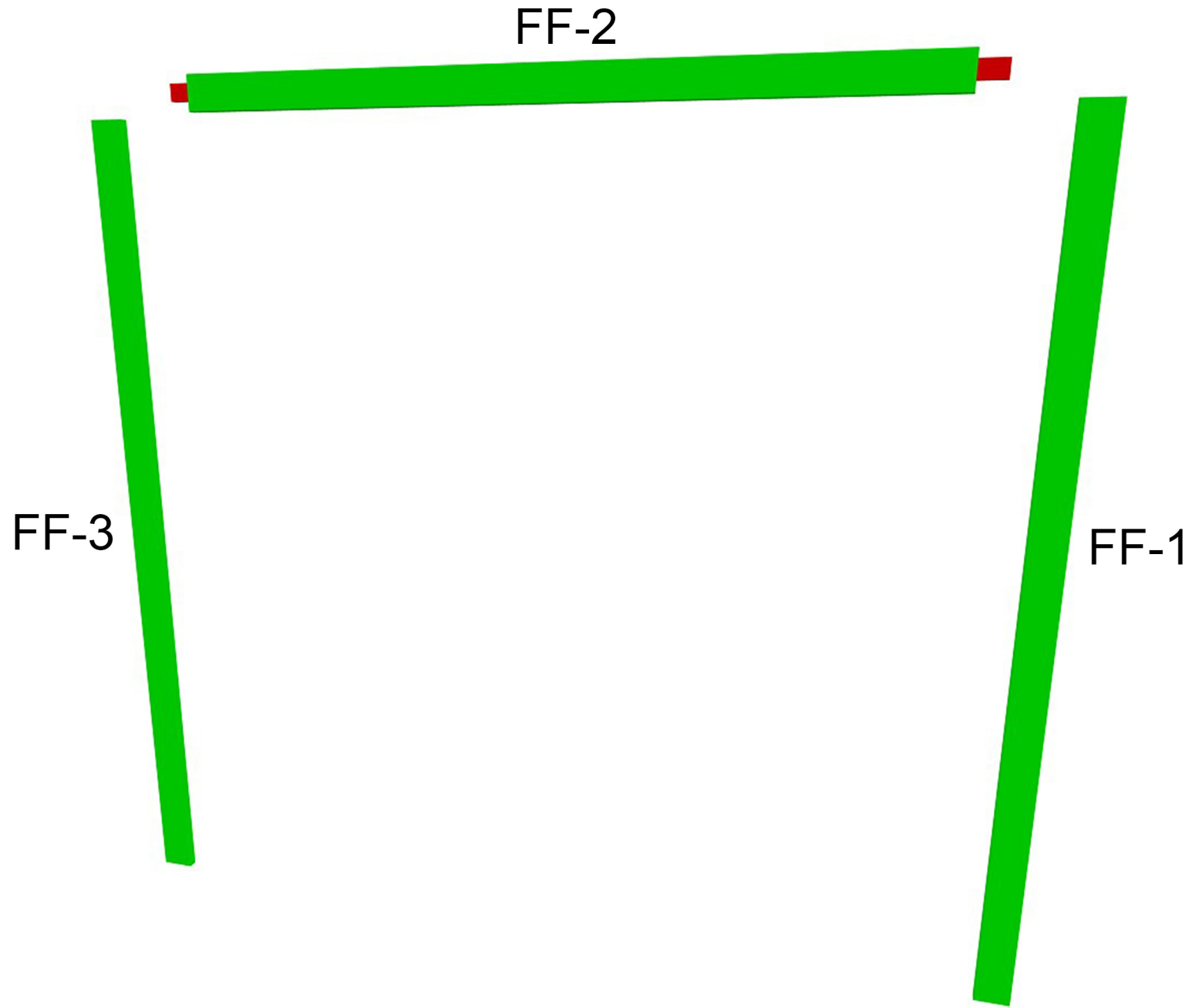

25. Fixing front frame

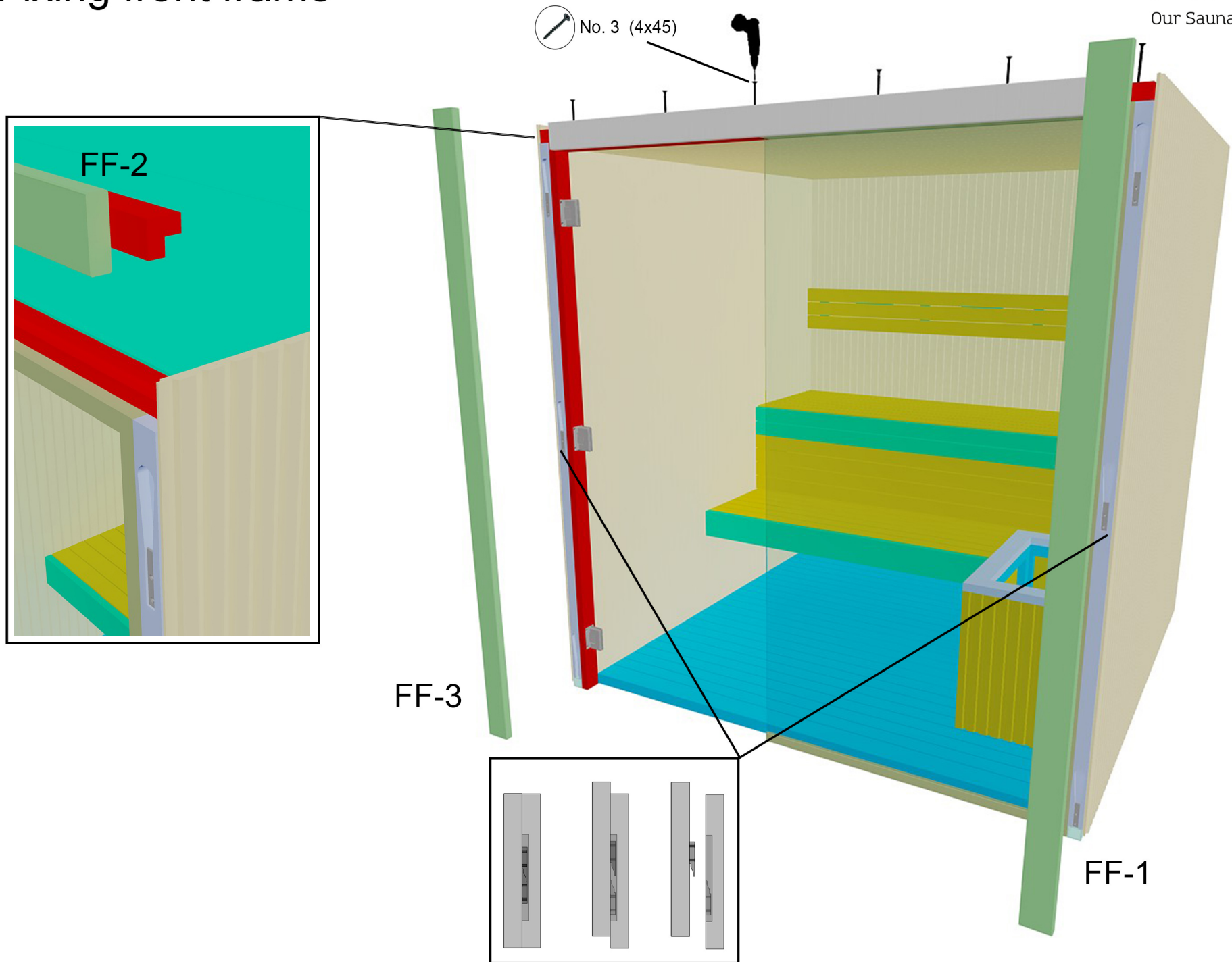

26. Door hinges and handle

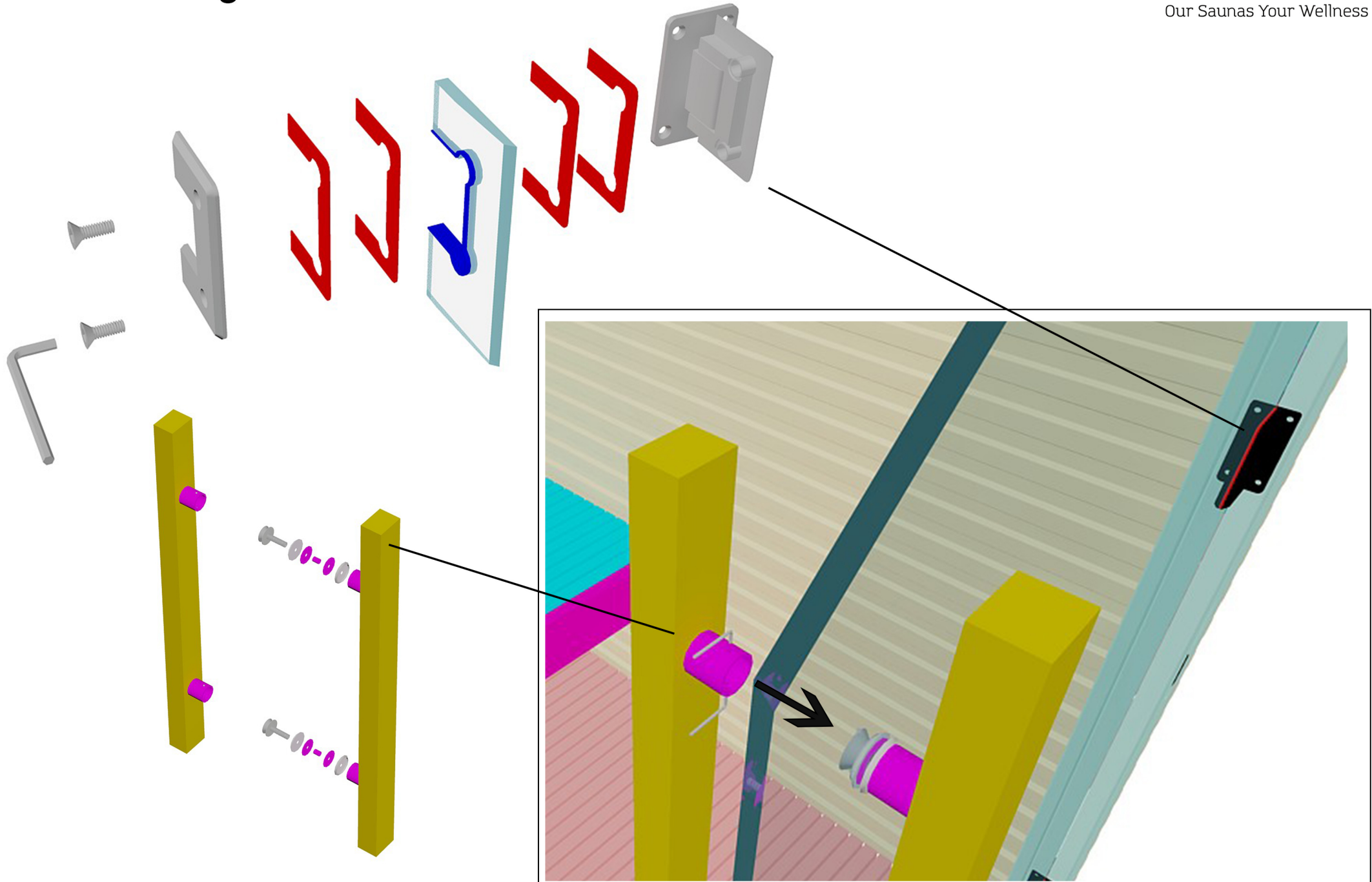

27. Wiring on ceiling

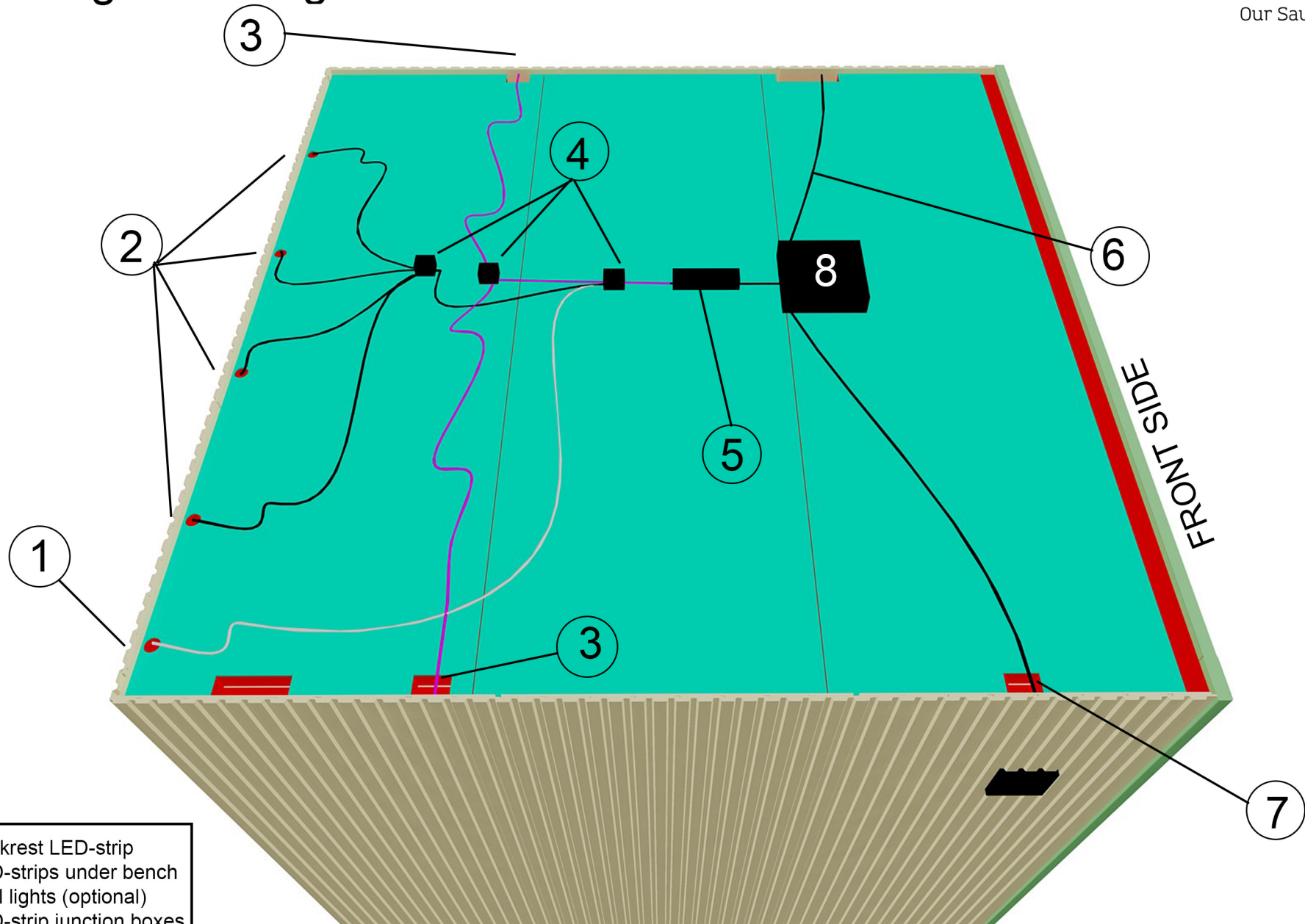

1. Backrest LED-strip
2. LED-strips under bench
3. Wall lights (optional)
4. LED-strip junction boxes
5. Transformer
6. Heater cable
7. Control unit cable
8. Power unit

Always use certified electrician

