

Irradia

Installation manual

Dimensions:

100x120 cm

100x150 cm

120x180 cm

150x150 cm

Handedness:

Left

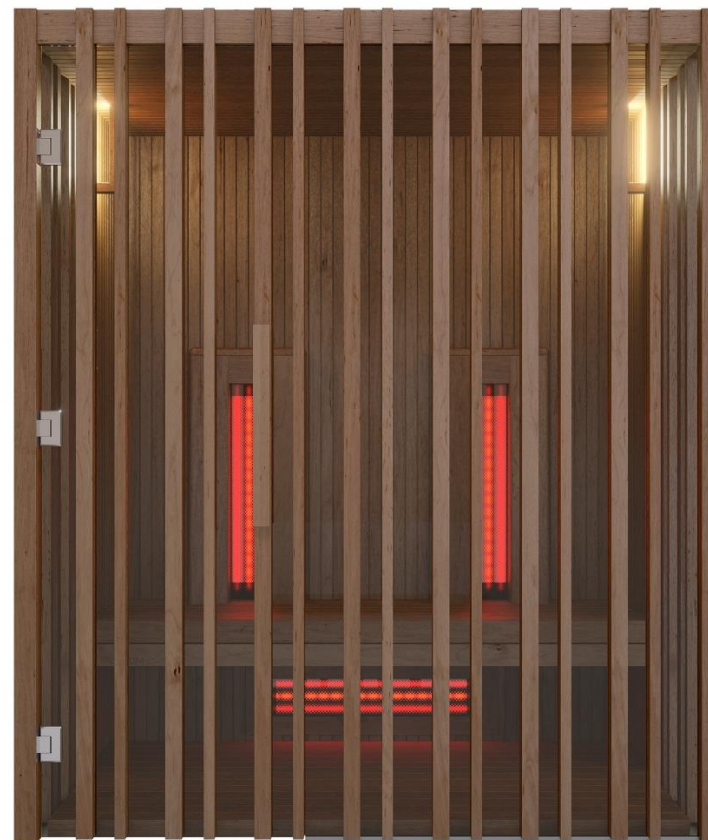

Leave space for better assembly

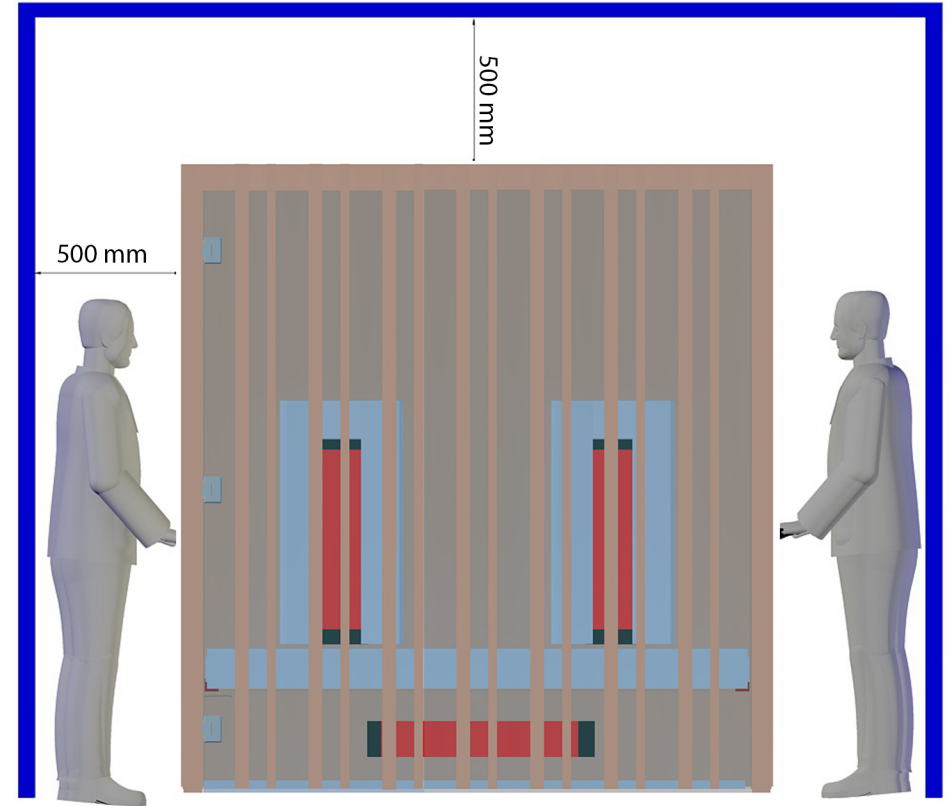
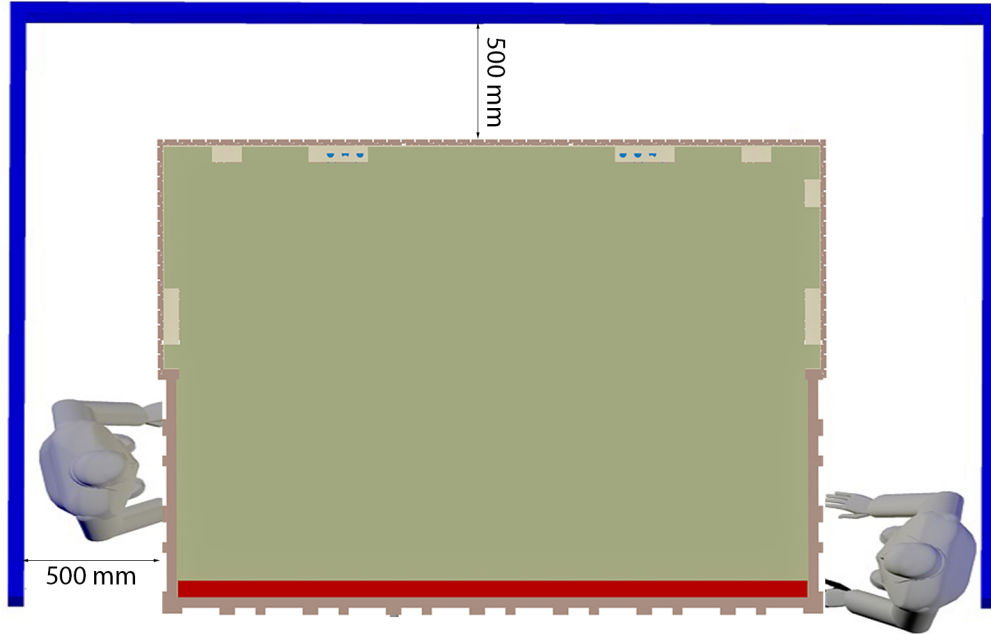

Tools



1. Base frame

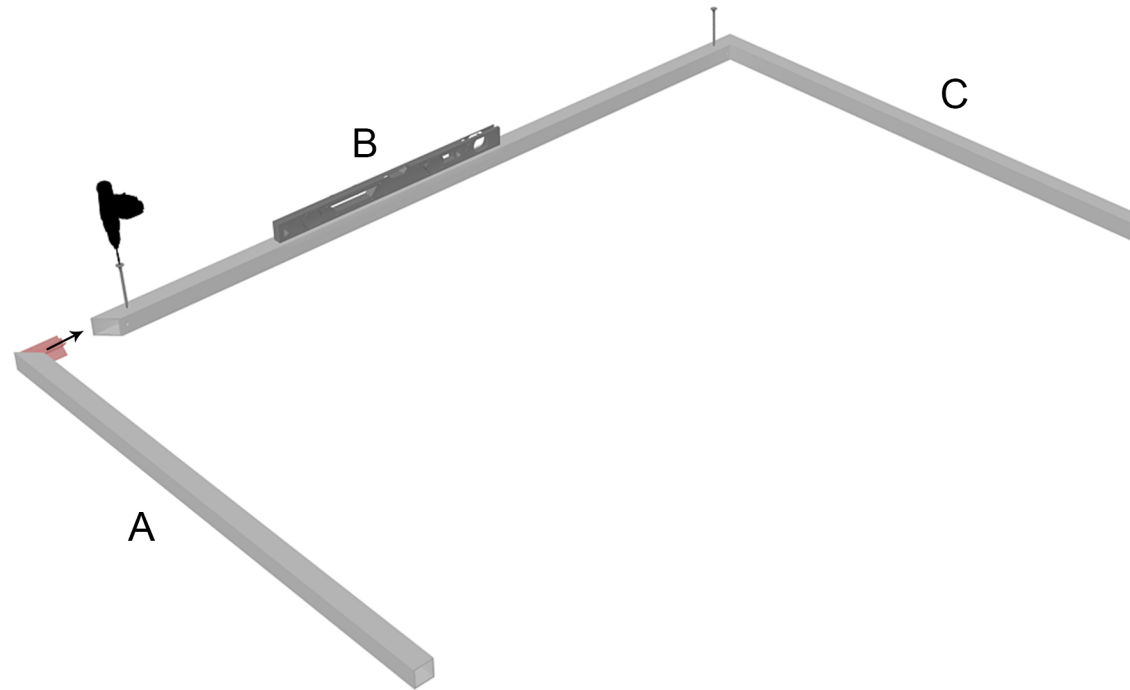

Aluminium

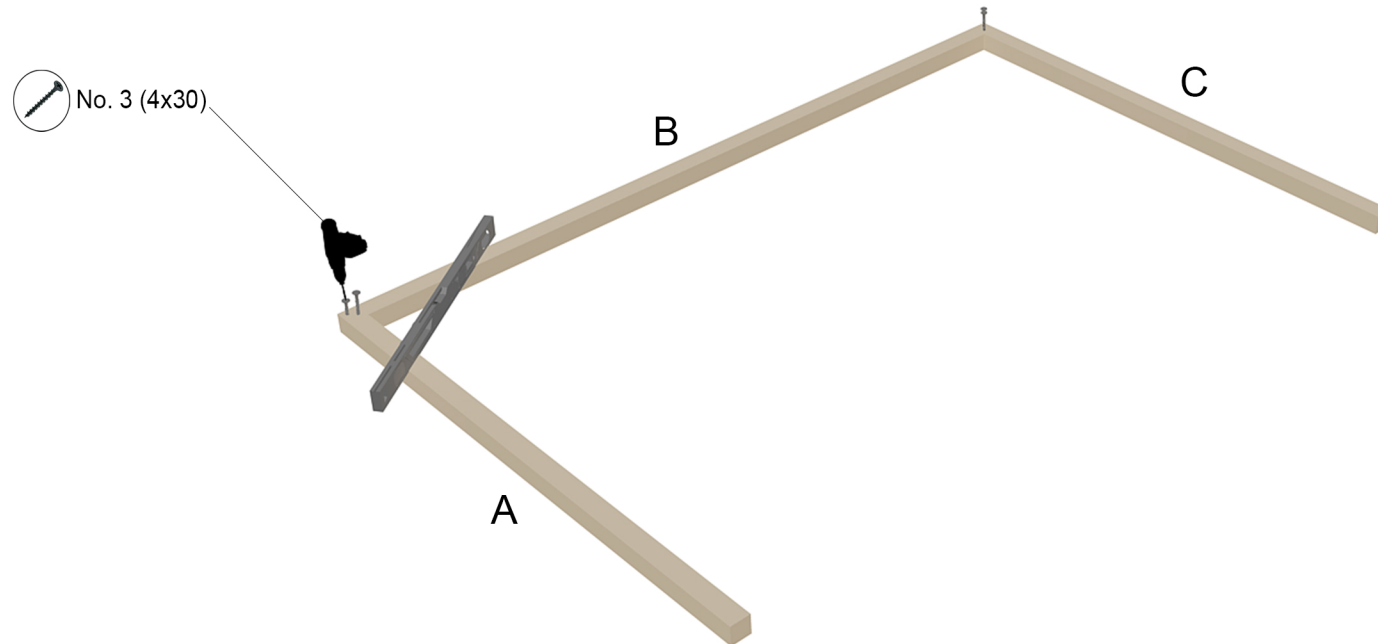

Wood

2. Walls

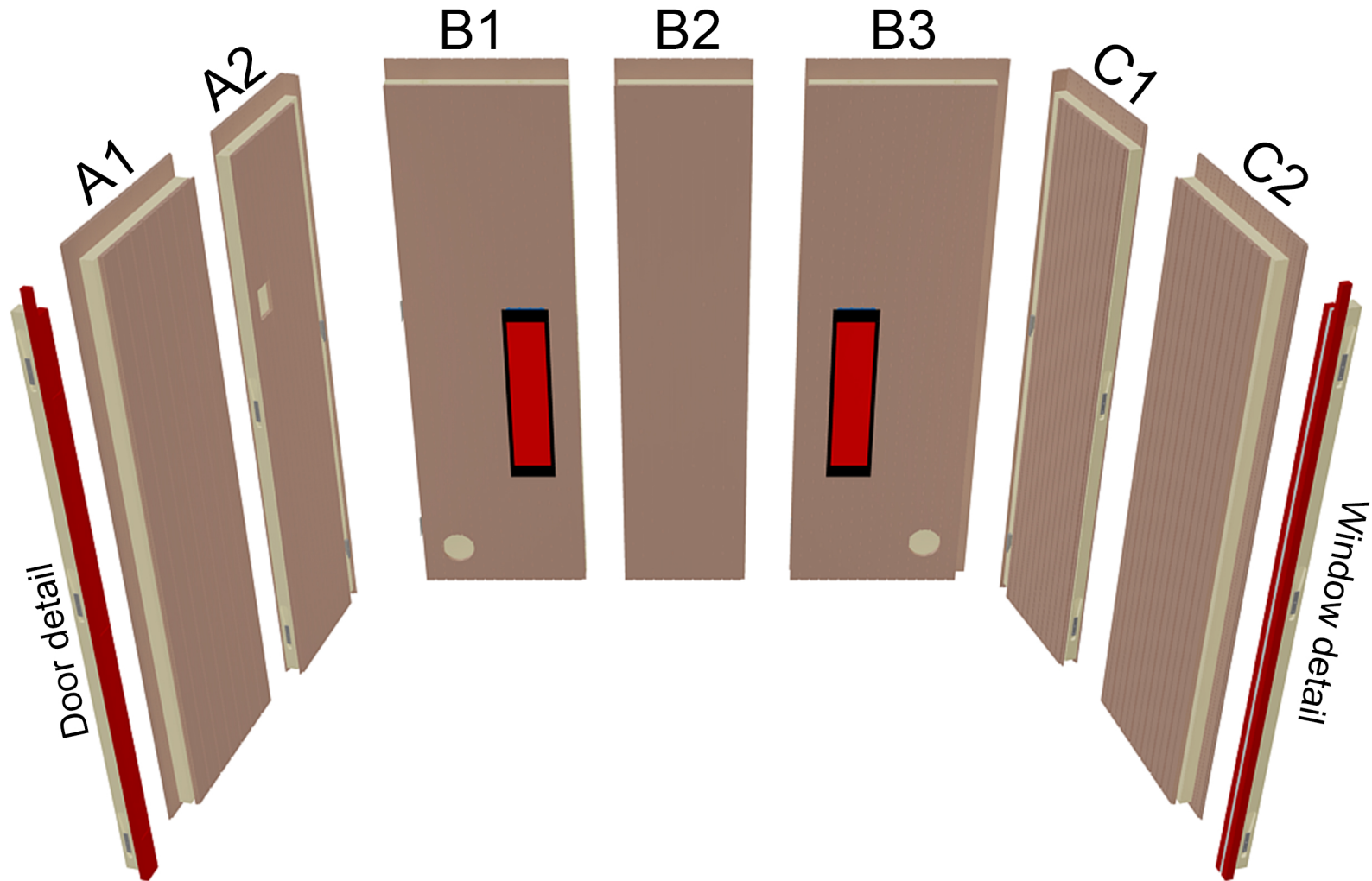

3. Multiclip closing system

1.

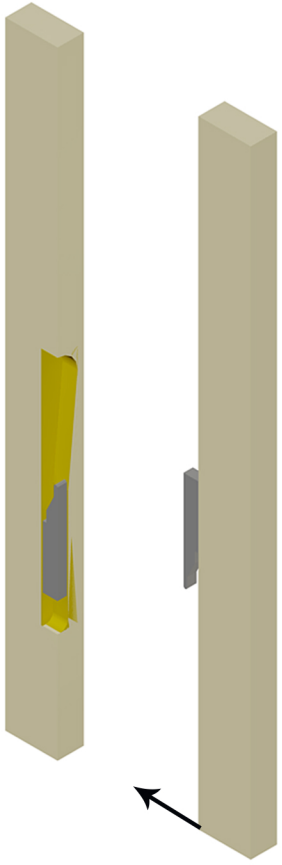

2.

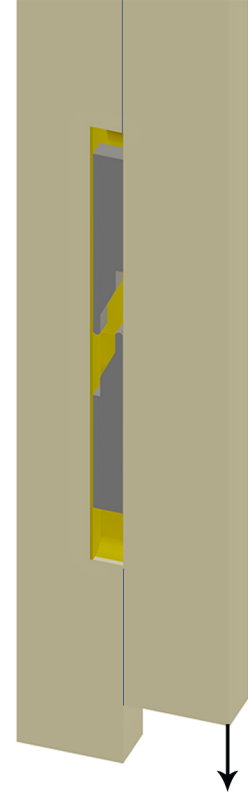

3.

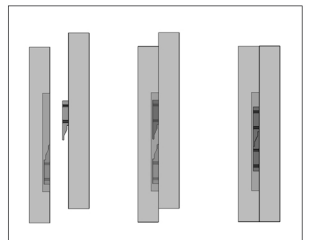
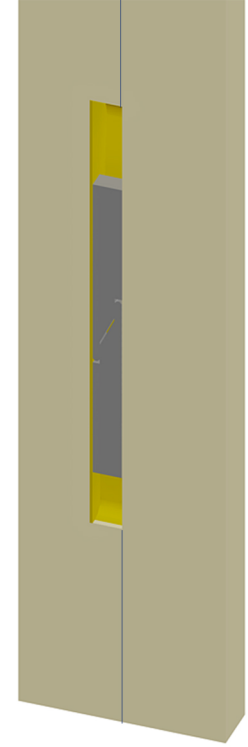

4. Fixing A & B walls

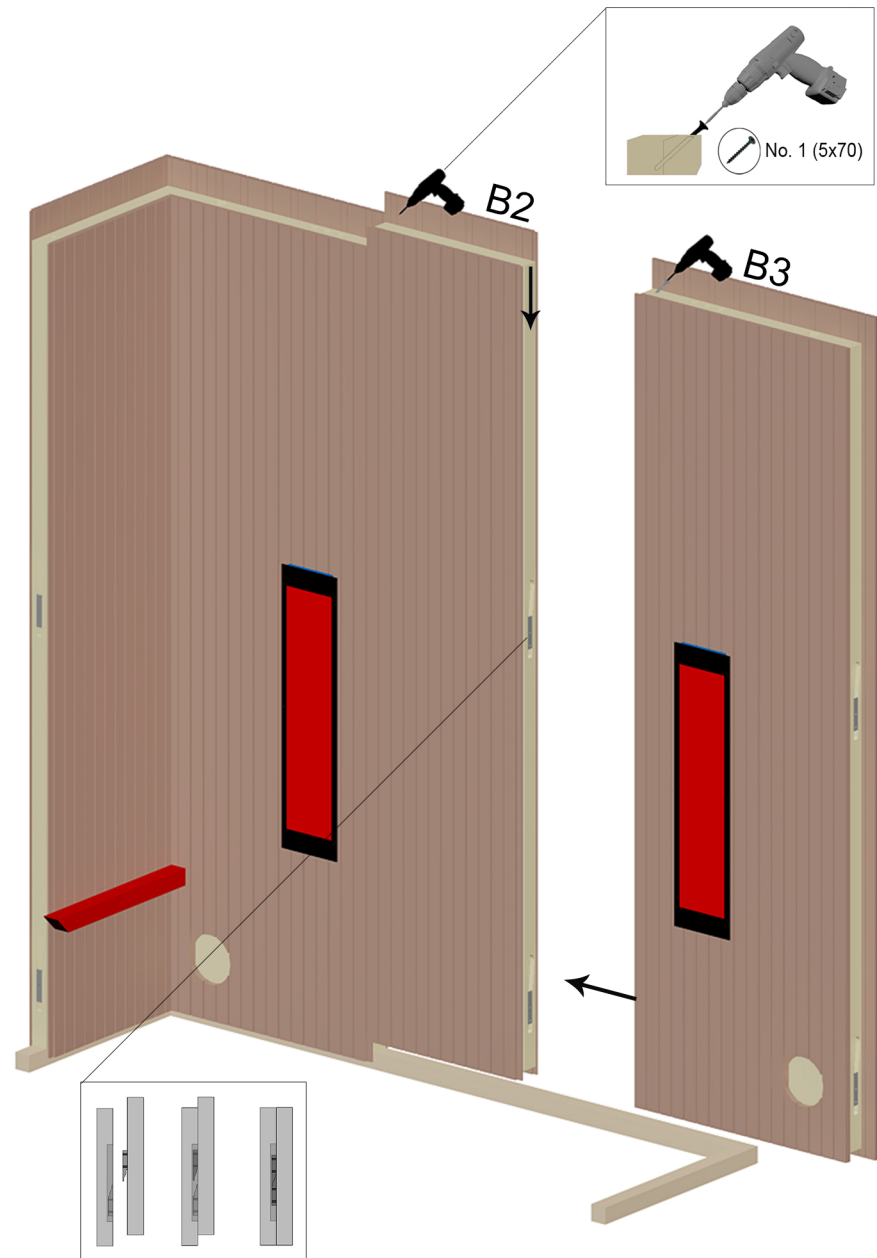
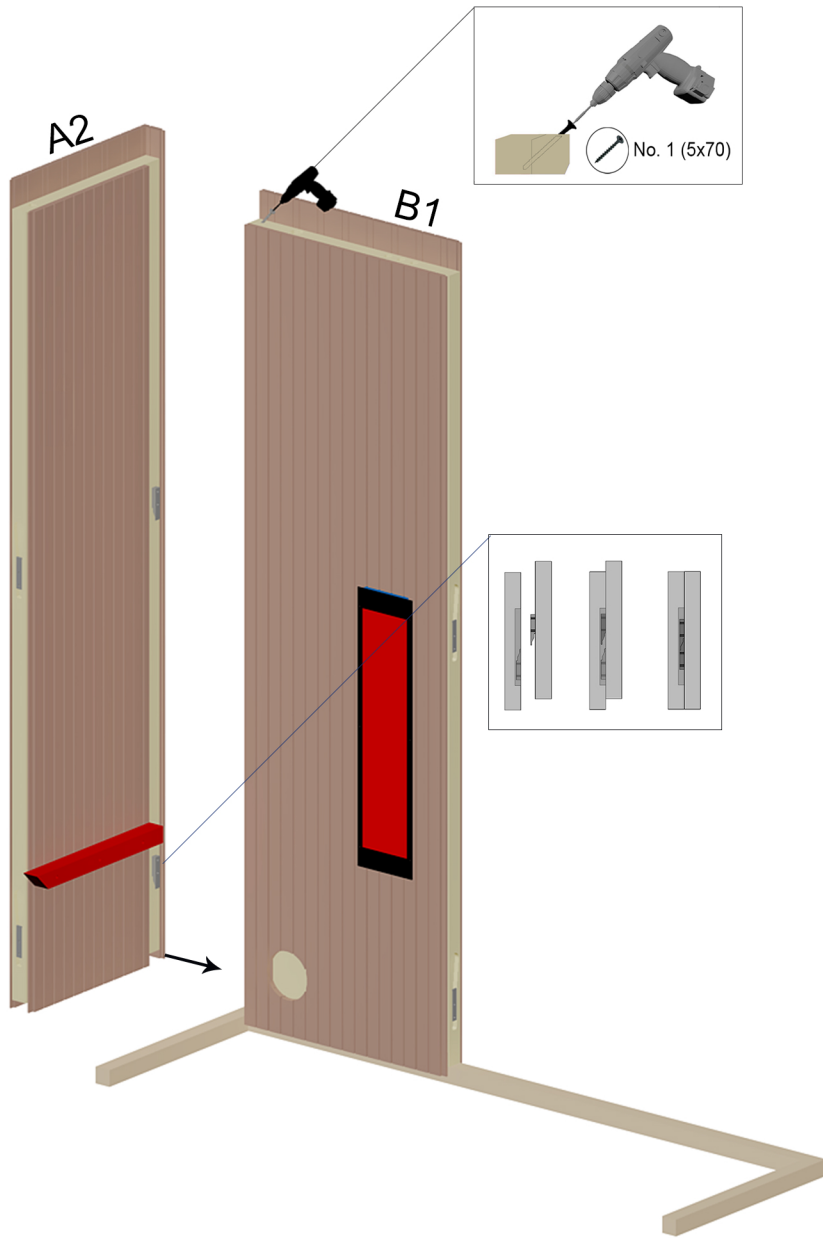

5. Fixing C & A walls

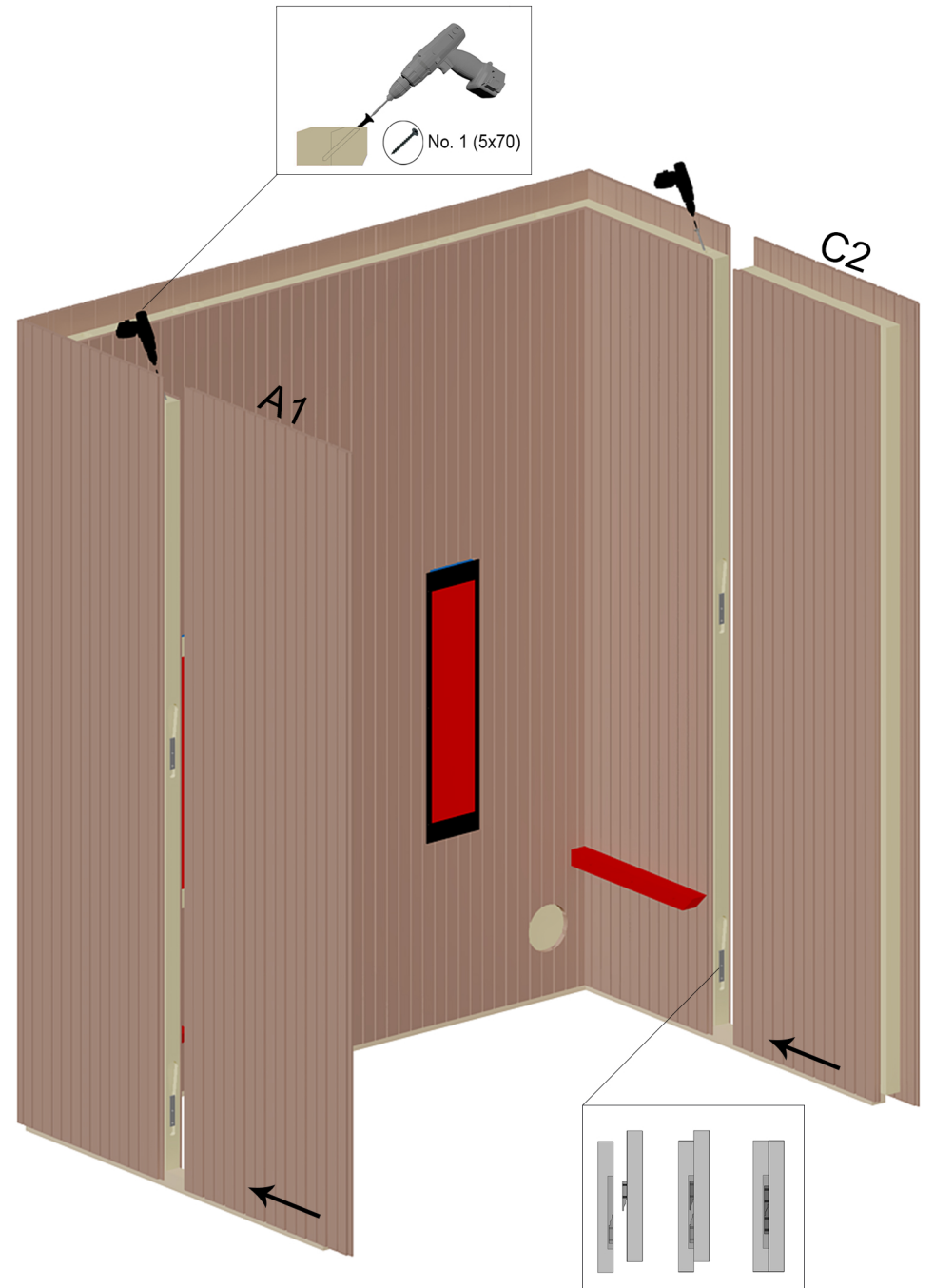
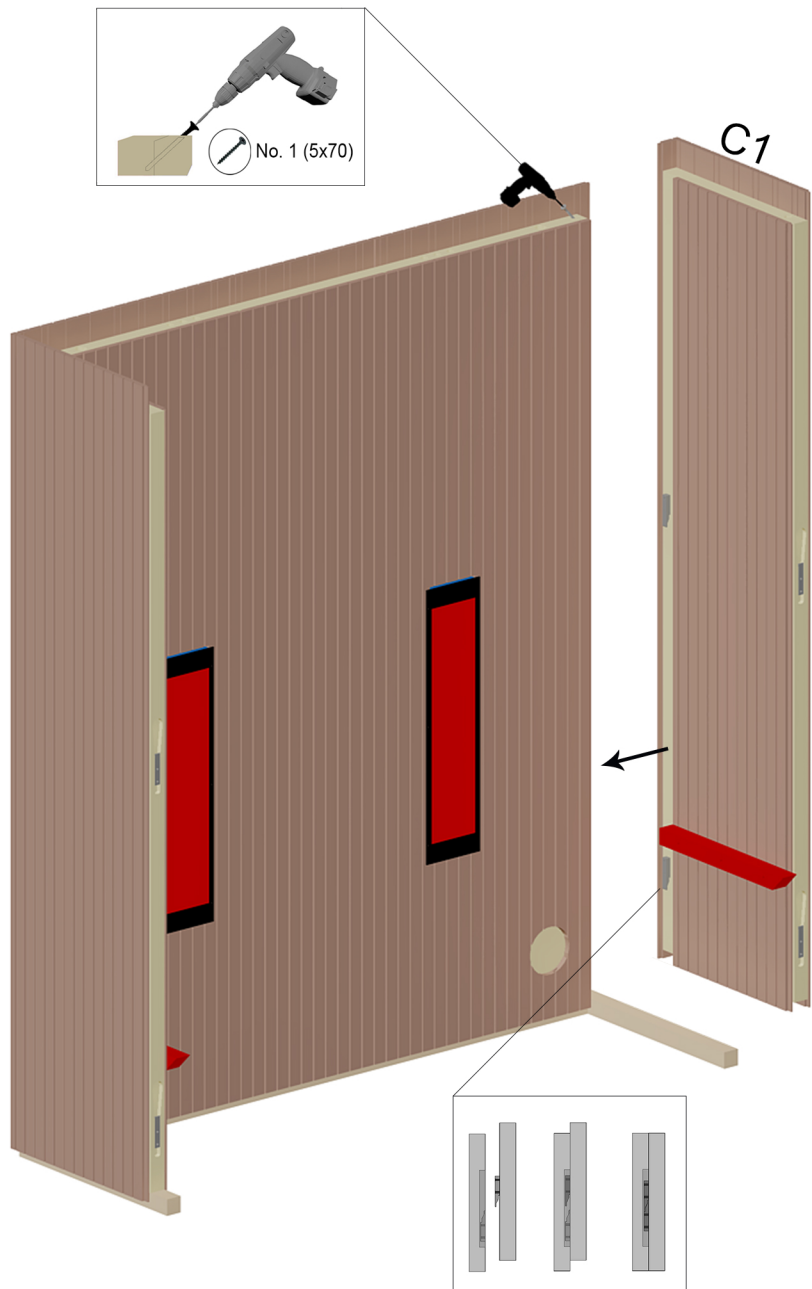

6. Fixing door & window details

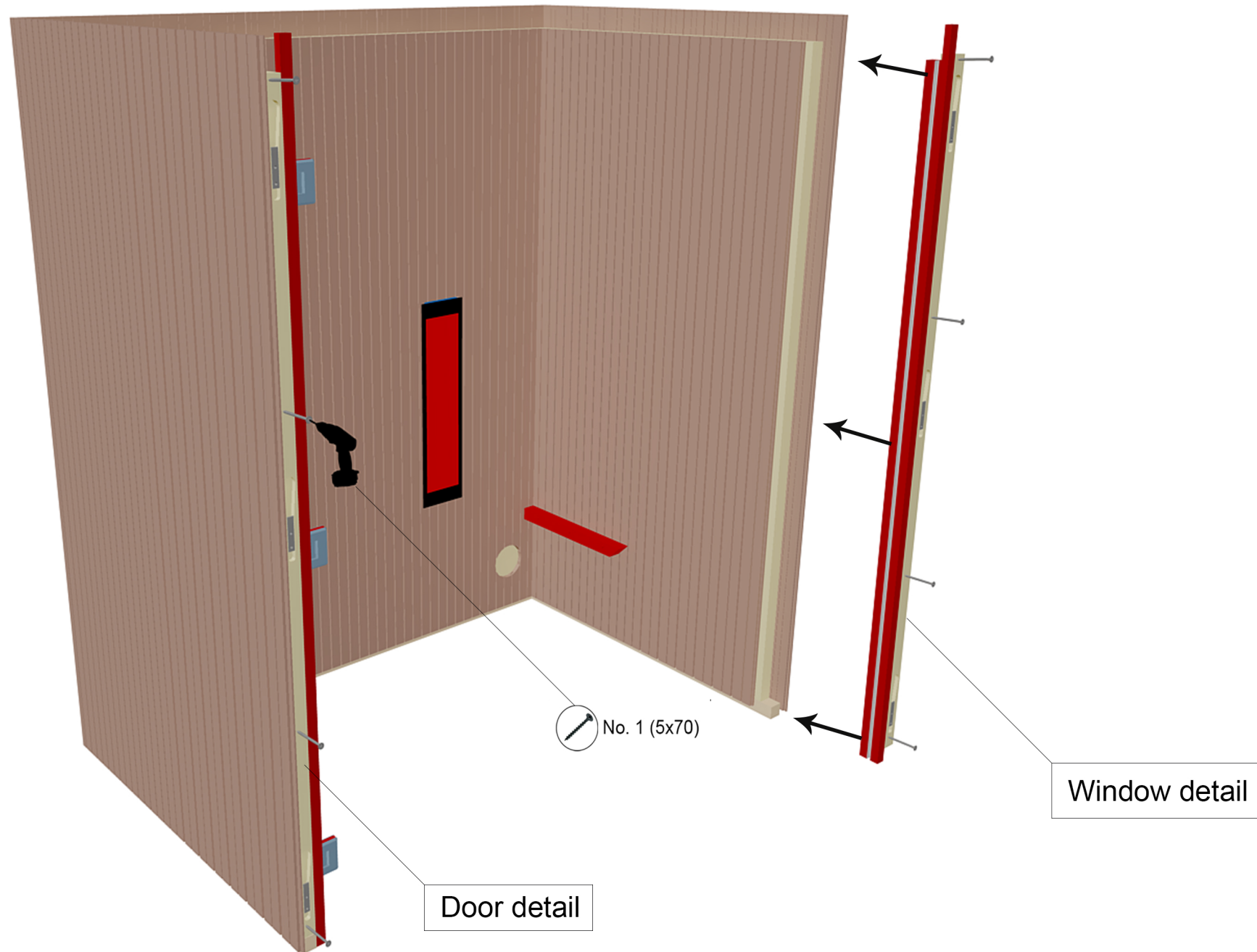

7. Fixing ceilings

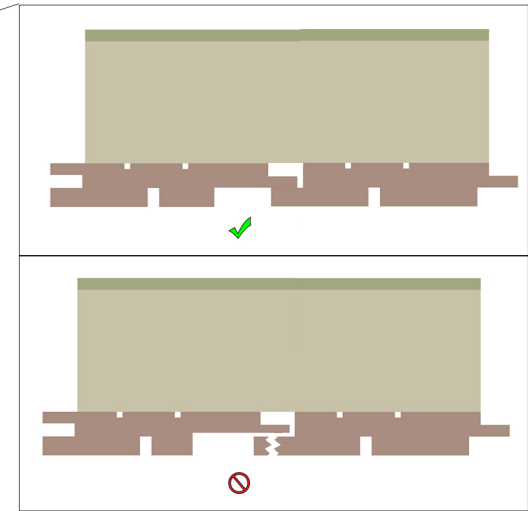
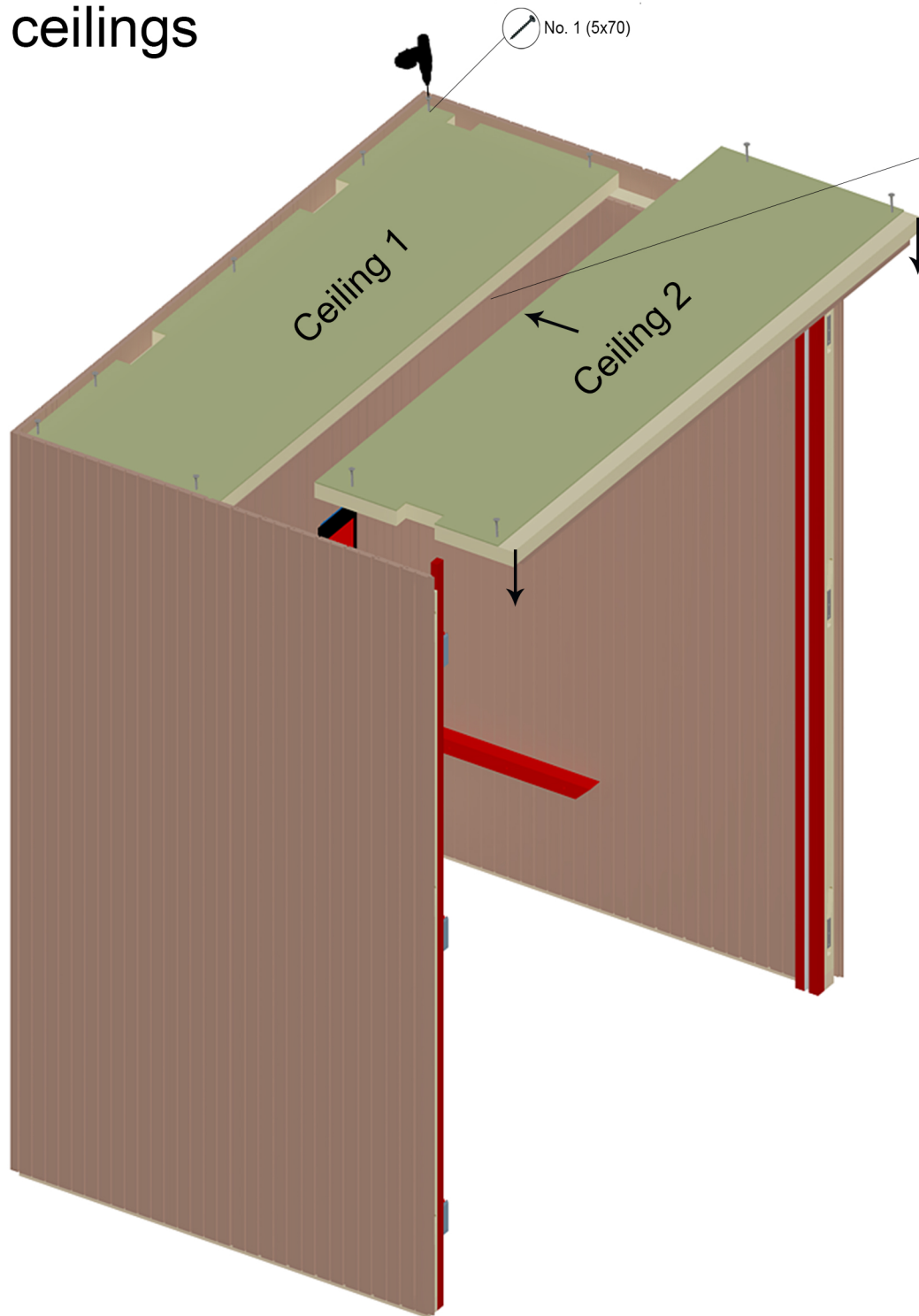

8. Fixing glass wall

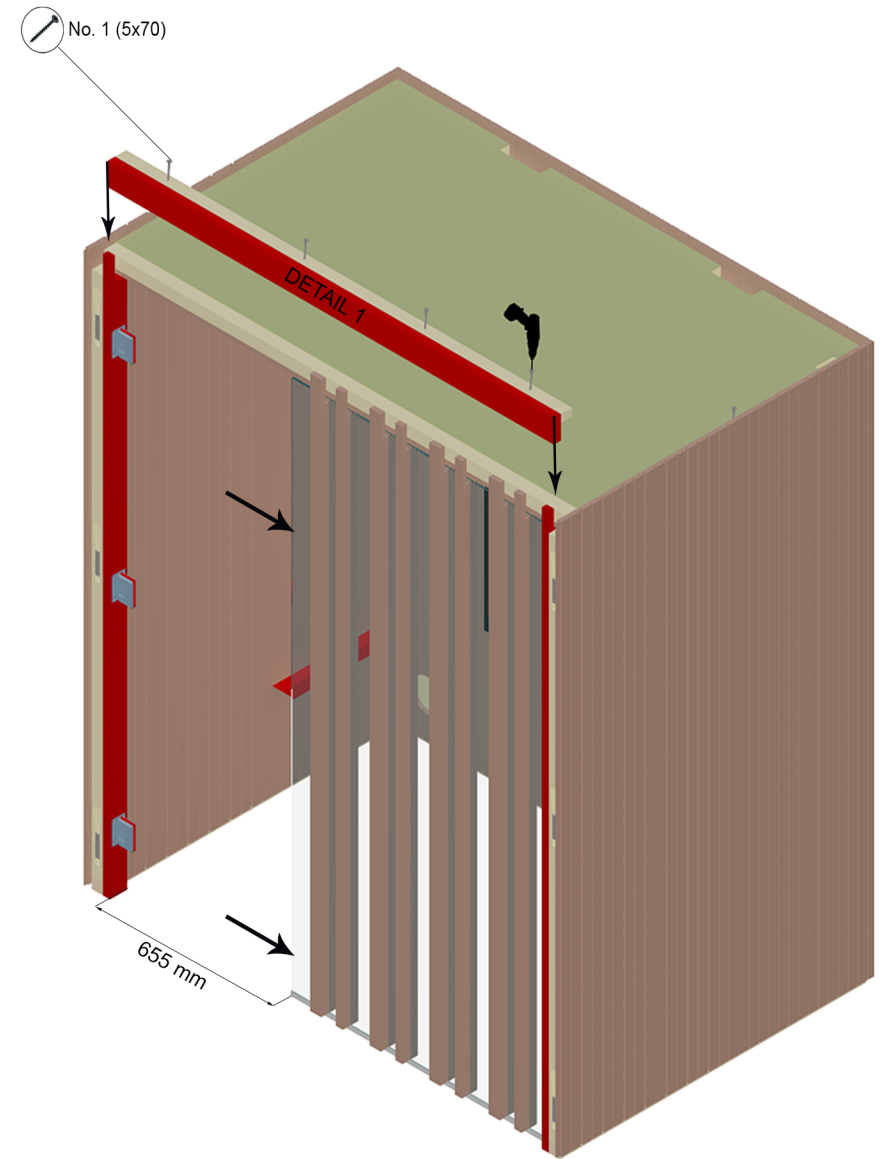
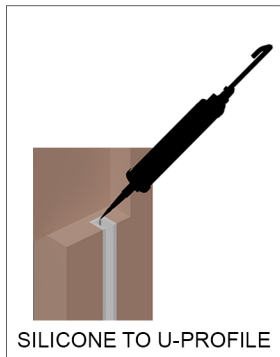
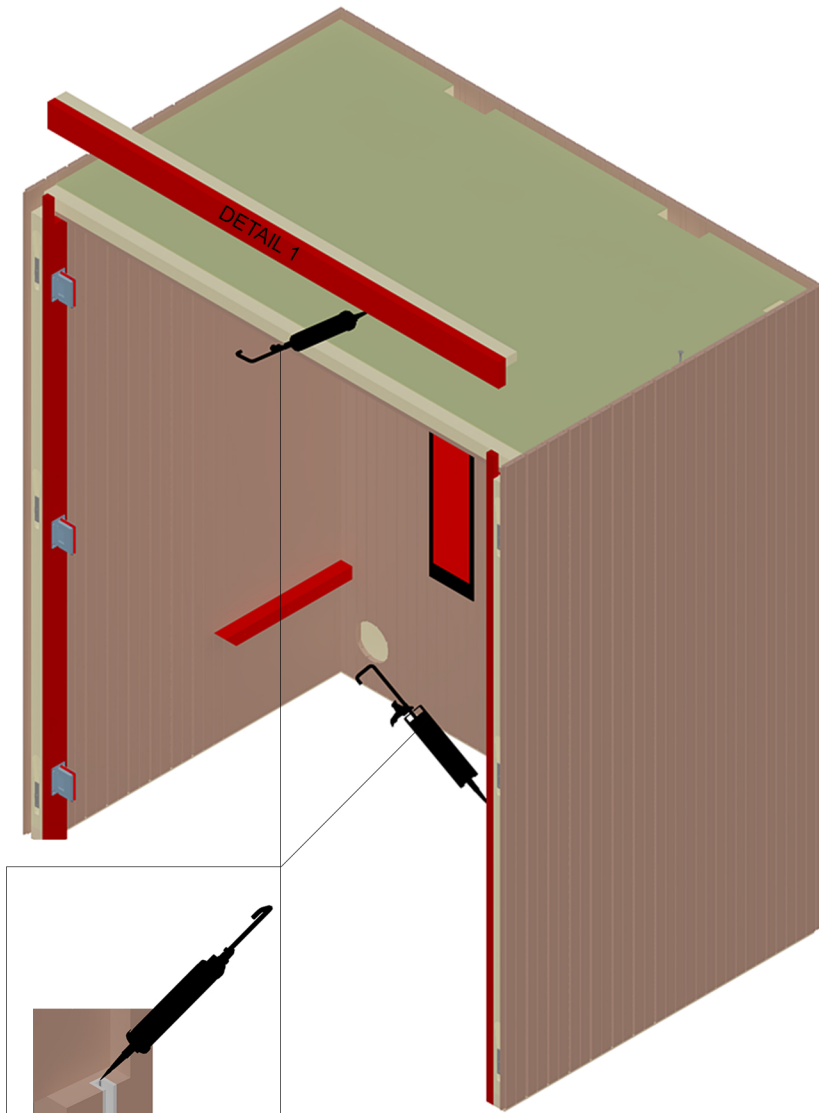

9. Interior

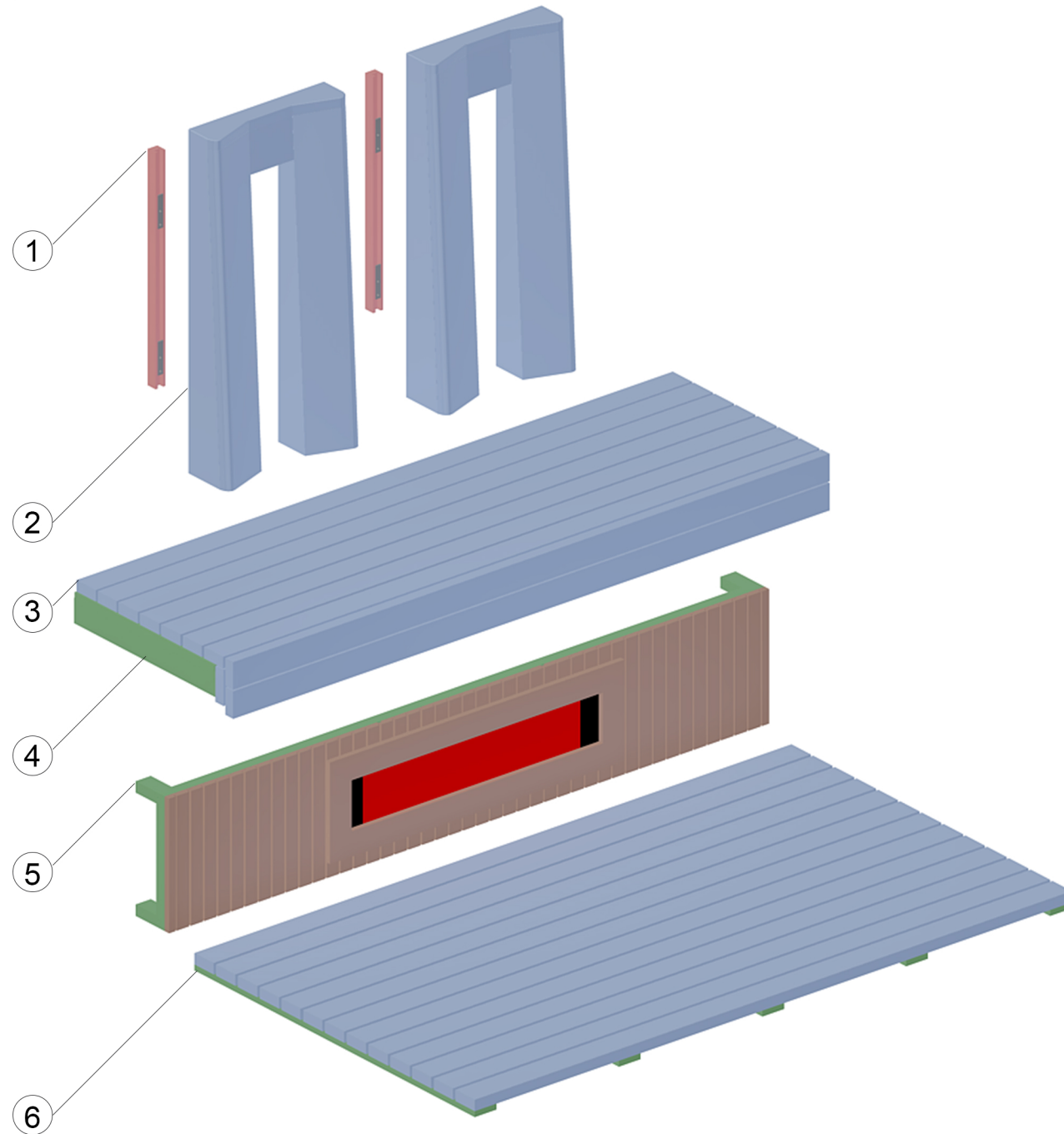

- 1. Backrest holders (4 pcs)
- 2. Backrest (2 pcs)
- 3. Bench grid
- 4. Bench frame
- 5. Benchskirt
- 6. Floor grids

10. Fixing bench skirt

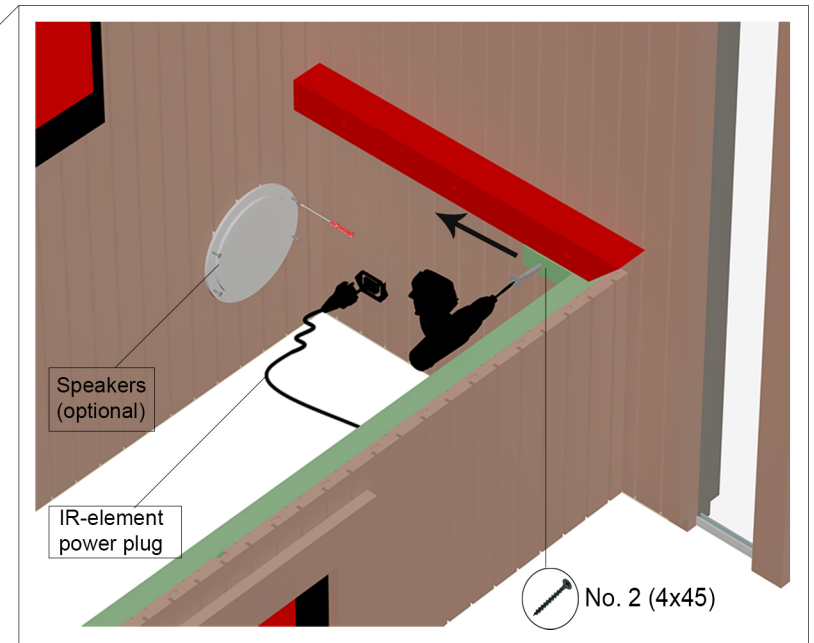
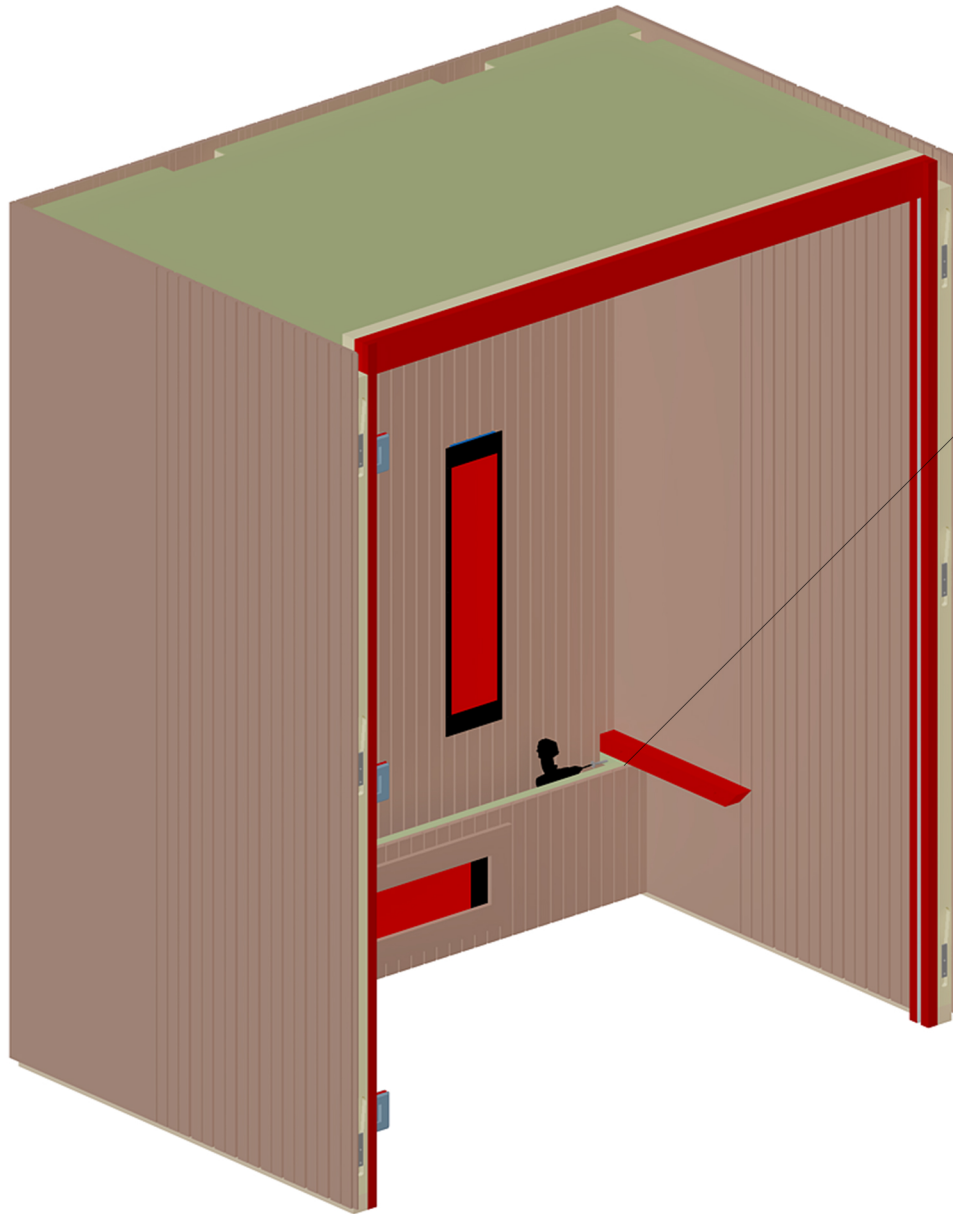

11. Fixing bench frame & bench grid

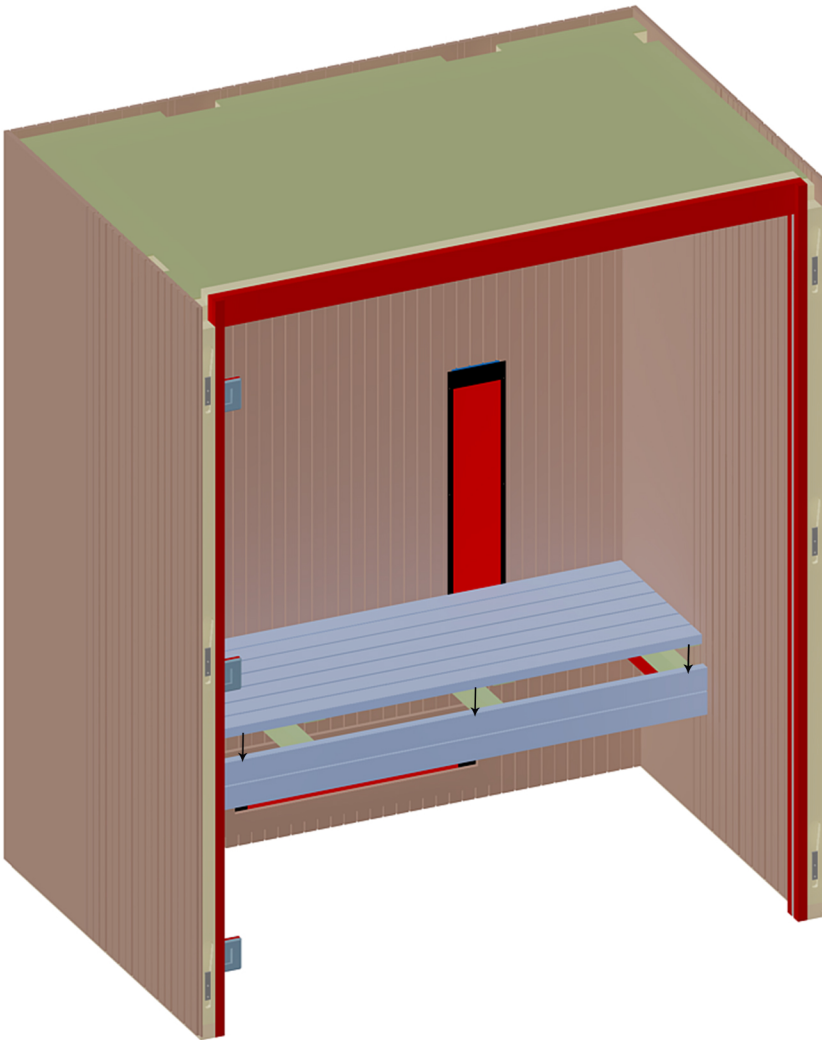
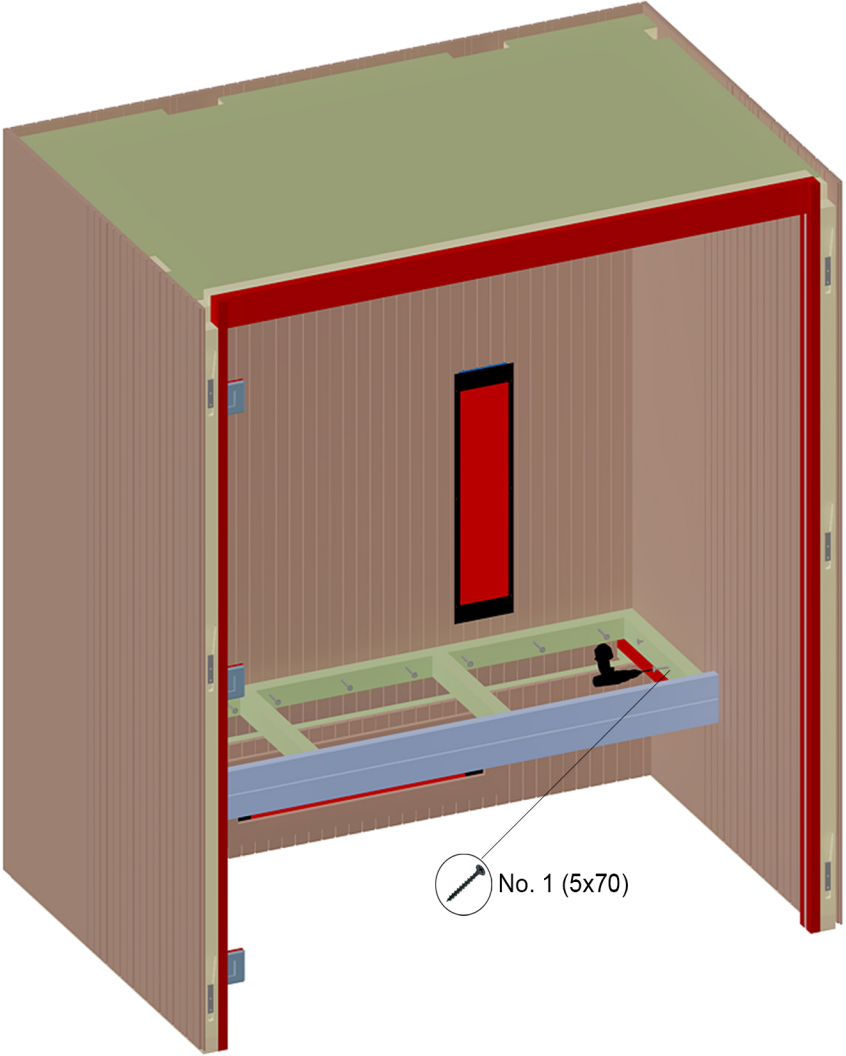

12. Fixing backrest

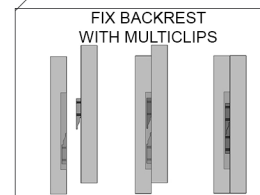
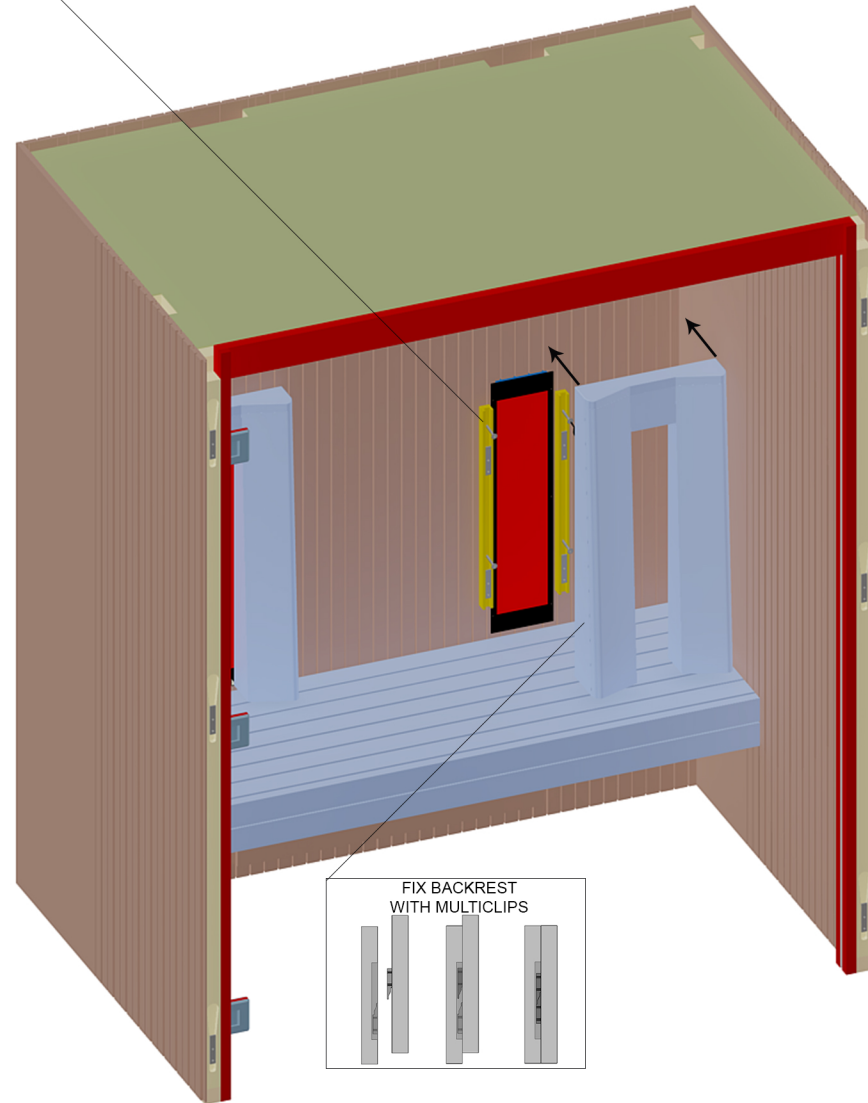
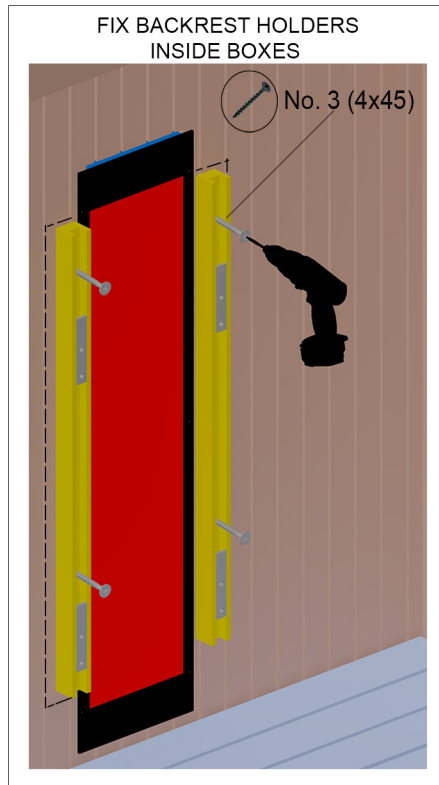

13. Floor grids

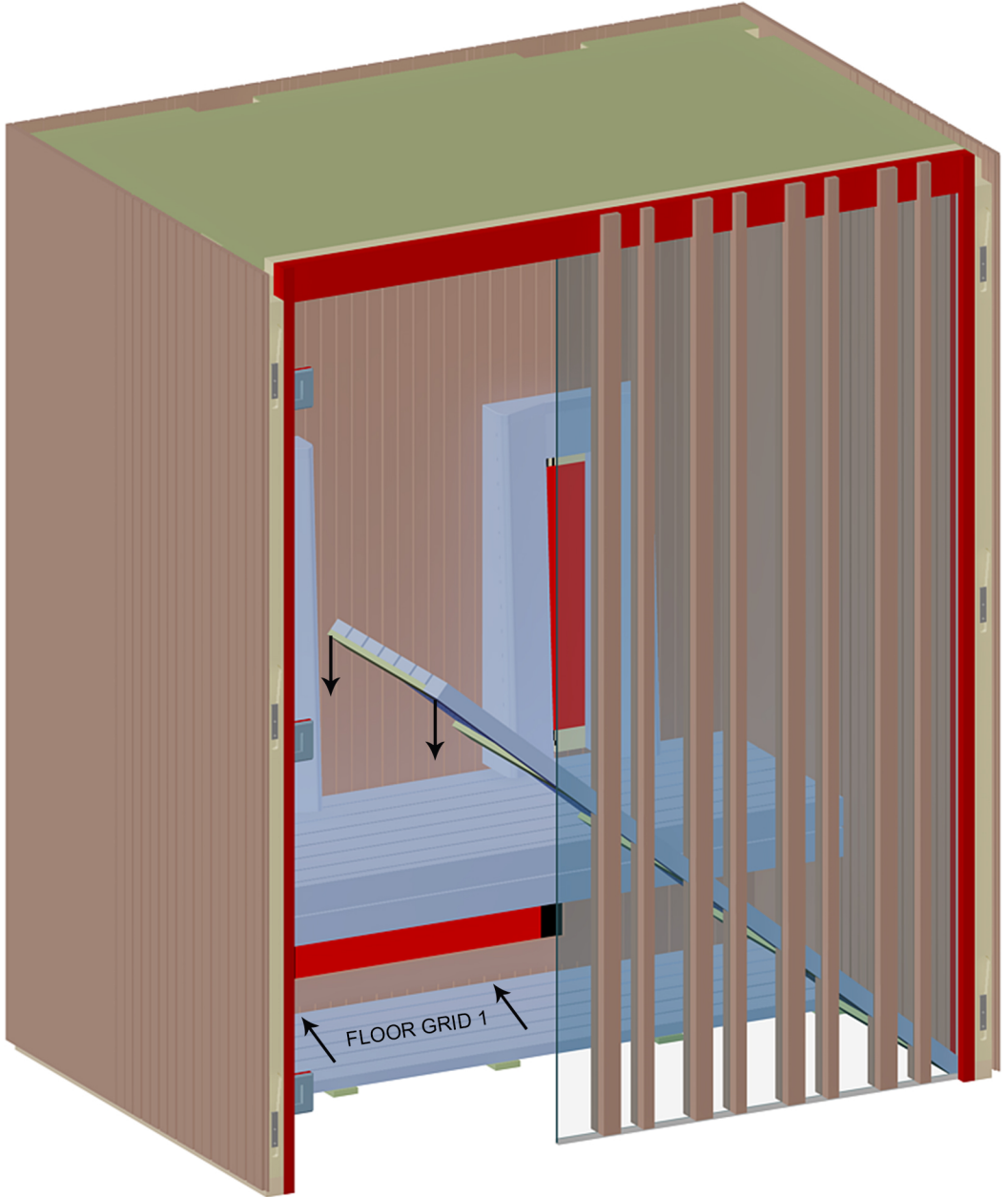

14. Fixing door & handle

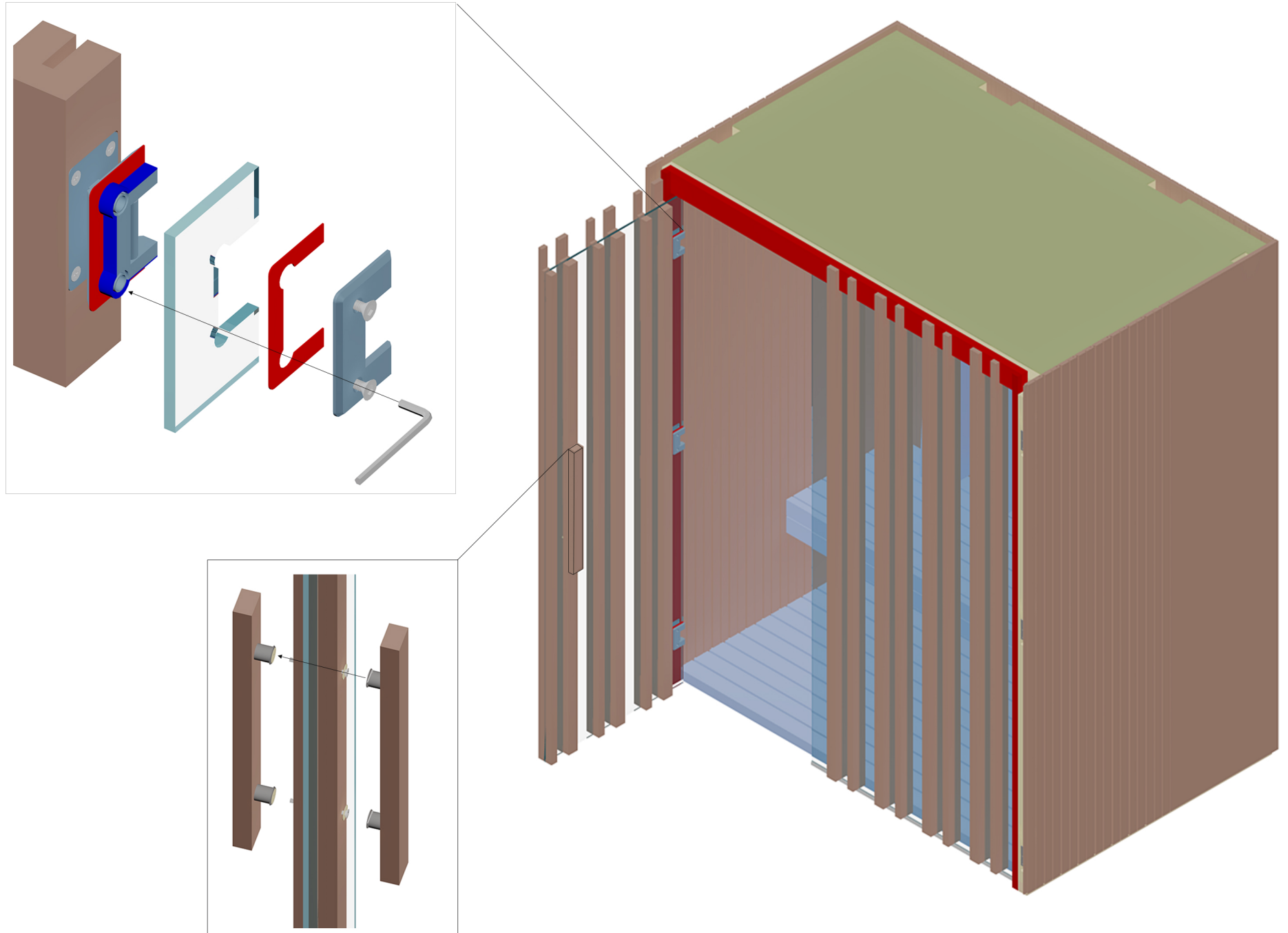

15. Fixing front frame

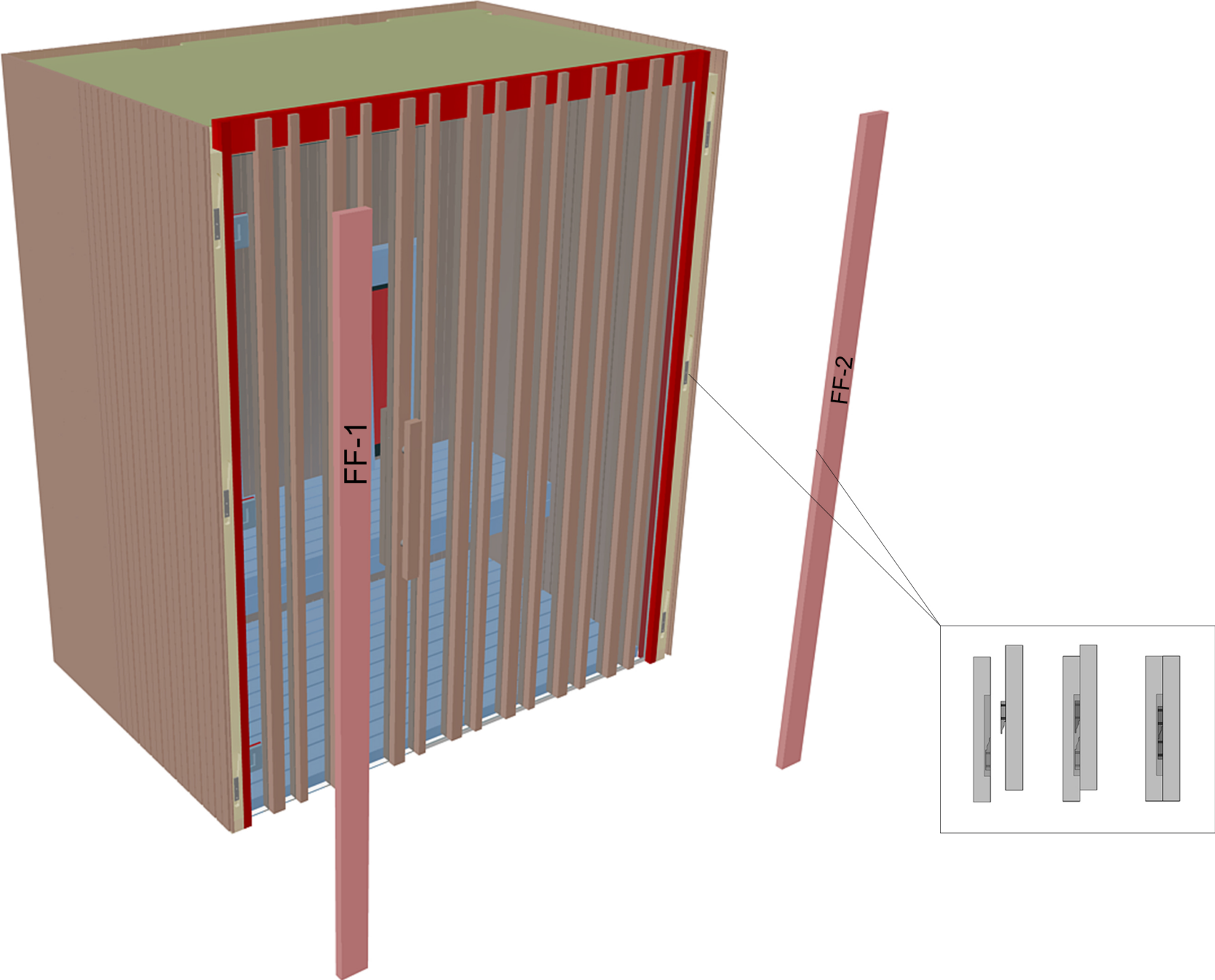

16. Electric shceme

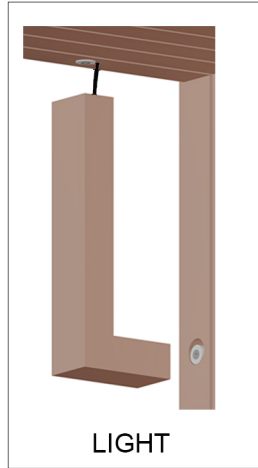

EOS LED-STRIP (LIGHT)

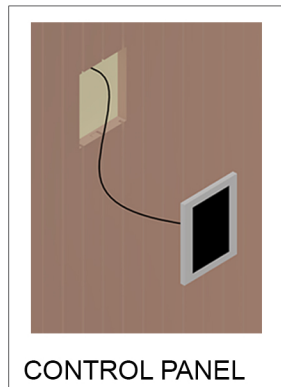

CONTROL PANEL

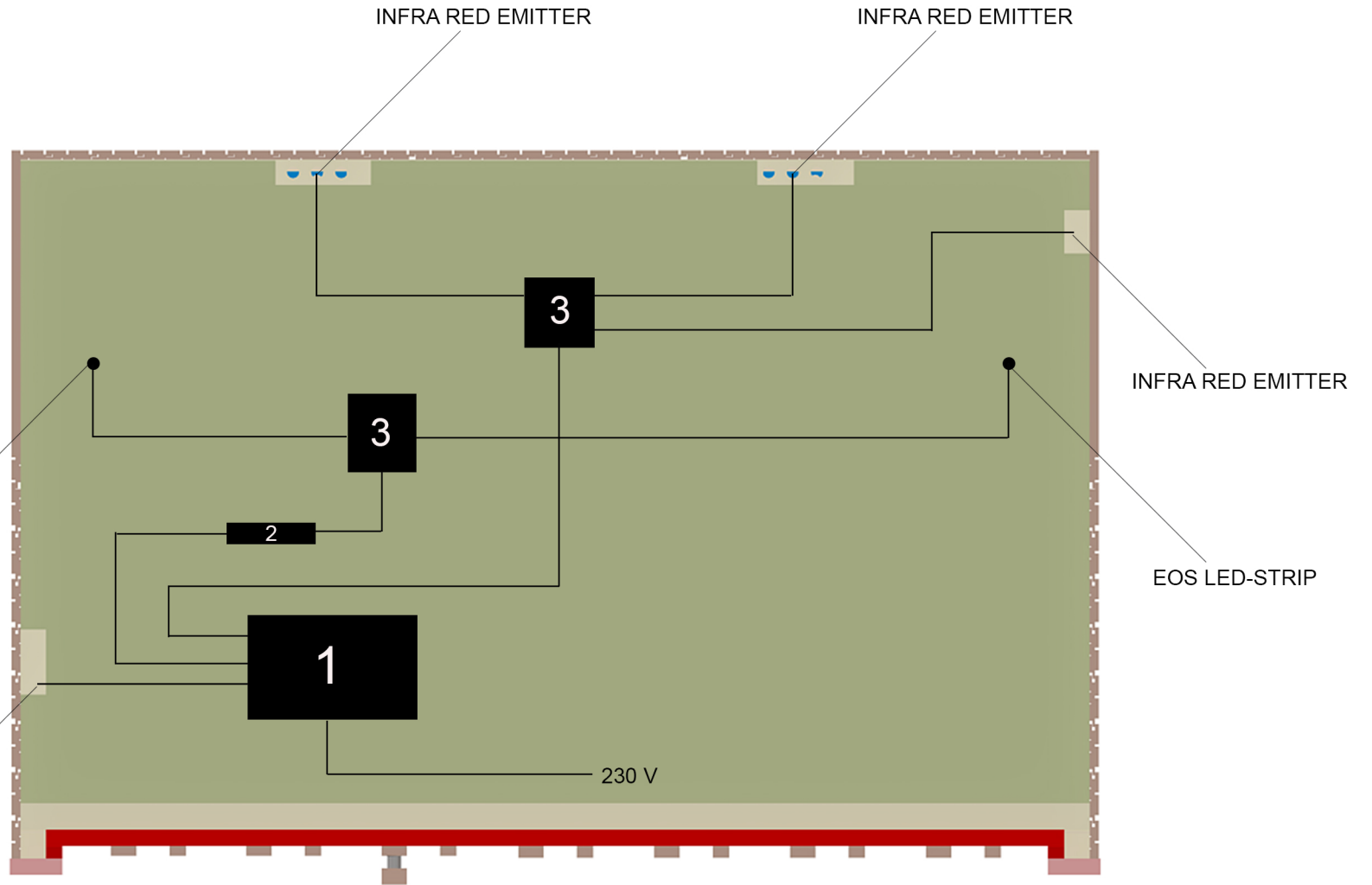

- 1. Power unit
- 2. Transformer
- 3. Junction box

Always use certified electrician !